

# EP 600

## Press Furnace



Valid as of  
Software Version V4.0

# Operating Instructions

# CE

**KONFORMITÄTSERKLÄRUNG  
DECLARATION OF CONFORMITY  
CERTIFICAT DE CONFORMITÉ  
DICHIARAZIONE DI CONFORMITÀ  
DECLARACIÓN DE CONFORMIDAD  
DECLARAÇÃO DE CONFORMIDADE**

**ivoclar  
vivadent**  
BENDERERSTR. 2  
FL-9494 LIECHTENSTEIN  
TEL ++423 / 235 35 35  
FAX ++423 / 235 33 60



Produkt / Product / Produit / Prodotto / Producto / Produto

**IPS Empress EP600**

- DE** Hiermit erklären wir in alleiniger Verantwortung, dass das oben aufgeführte Produkt den erwähnten Normen entspricht.  
Gemäss den Bestimmungen der EU-Richtlinie(n):
- GB** We herewith declare that the product listed above complies with the mentioned standards.  
Following the provisions of Directive(s):
- FR** Par la présente, nous déclarons que le produit ci-dessus indiqué est conforme aux normes énoncées.  
Conformément aux dispositions de la (des) Directive(s) CE:
- IT** Con la presente dichiariamo sotto la nostra responsabilità, che il prodotto sopra menzionato corrisponde alle norme citate.  
Secondo le disposizioni della/e Direttiva/e CEE:
- ES** Por la presente declaramos que el producto arriba indicado cumple con las normas citadas.  
Siguiendo las indicaciones de la Directiva:
- PT** Declaramos que o produto citado cumpre as normas mencionadas.  
De acordo com as especificações da(s) Diretriz(es):

73/23/EWG 89/336/EWG	EN 50081-1	1992
	EN 50082-1	1997
	EN 61010-1	1990
	EN 61010-1/A1	1992
	EN 61010-1/A2	1995
	EN 61010-2-010	1992
	EN 61010-2-010/A1	1996
	EN 61326-1	1998

Schaan, 25.02.2003

Bürs, 25.02.2003

Dipl. Ing. Wolfgang Vogrin

Geschäftsleitung Produktion und Technik<sup>(1)</sup>  
Ivoclar Vivadent AG, FL-9494 Schaan

Markus Stadlmayr

Produktionsmanager<sup>(2)</sup>  
Ivoclar Vivadent GmbH, A-6706 Bürs  
(Hersteller)<sup>(3)</sup>

<sup>(1)</sup> Board of directors Production and Engineering / Membres du Directoire Production et Technique / Direzione Produzione e Tecnica / Miembro consejo administración, Director de Producción y D. Técnico / Diretoria de Produção e Tecnologia

<sup>(2)</sup> Manager / Directeur / Amministratore / Director / Gerente

<sup>(3)</sup> Manufacturer / Fabricant / Produttore / Fabricante / Fabricante

Rev. 1.3

# Table of Contents

	Page
<b>Views of the Furnace, List of Parts</b>	<b>4</b>
<b>1 Introduction / Signs and Symbols</b>	<b>8</b>
1.1 Preface	
1.2 Signs and Symbols	
1.3 Notes regarding the Operating Instructions	
<b>2 Safety First</b>	<b>9</b>
2.1 Indications	
2.2 Health and safety instructions	
<b>3 Product Description</b>	<b>13</b>
3.1 Components	
3.2 Hazardous areas and safety equipment	
3.3 Functional description	
3.4 Accessories	
<b>4 Installation and Initial Start-Up</b>	<b>14</b>
4.1 Unpacking and checking the contents	
4.2 Selecting the location	
<b>5 Operation and Standard Settings</b>	<b>18</b>
5.1 Starting the furnace	
5.2 Introduction to the operation 'Pressing'	
5.3 Introduction to the operation 'Miscellaneous'	
5.4 Operating the menu / key functions	
5.5 Help function	
5.6 Protocol	
<b>6 Practical Use</b>	<b>23</b>
6.1 Switching on/off	
6.2 Standard programs	
<b>7 Maintenance, Cleaning, and Diagnosis</b>	<b>24</b>
7.1 Monitoring and maintenance	
7.2 Cleaning	
7.3 'Access alarm table' menu	
7.4 'Diagnostic programs' menu	
7.5 Temperature calibration	
7.6 Changing the press plunger	
<b>8 What If...</b>	<b>27</b>
8.1 Error messages and notifications (alarm)	
8.2 Technical malfunctions	
8.3 Repair	
<b>9 Product Specifications</b>	<b>30</b>
9.1 Delivery form	
9.2 Technical data	
9.3 Acceptable operating conditions	
9.4 Acceptable transportation and storage conditions	
<b>10 Miscellaneous</b>	<b>32</b>
10.1 Press table	
10.2 Menu structure of the EP 600	

# List of Parts

## A = Furnace Base

- 1 Sagger tray BP1
- 2 Screws for sagger tray
- 3 Rubber foot
- 4 Air vents
- 5 On/Off switch
- 6 Power socket
- 7 Vacuum pump socket
- 8 External vacuum pump fuse
- 9 Heater fuse
- 10 Controls fuse
- 11 Rating plate
- 12 Vacuum hose connection
- 13 Vacuum hose
- 14 PC printer connection (RS-232)
- 15 Opening for the operating pin
- 16 Press drive socket
- 17 Heater plug socket
- 18 Thermocouple socket
- 19 Sealing surface
- 20 Fuse holder
- 21 Power cord
- 22 Plug for power cord
- 23 Plug-in for ground connection
- 24 Recess for ATK1
- 25 Support for tray

## B = Furnace Head with Press Mechanism

- 50 Firing plate
- 51 Screws for furnace head connections cover
- 52 Press drive cover
- 53 Furnace head cover
- 54 Furnace head connections cover
- 55 Screws for press drive cover
- 56 Press plunger EP600 (red)
- 57 Terminal screw for press plunger
- 58 Cover for press electronics
- 59 Press electronics
- 60 Split taper socket for press plunger
- 61 Press drive cable
- 62 Thermocouple cable
- 63 Heater cable
- 64 Thermocouple plug
- 65 Press drive plug
- 66 Heater plug
- 67 Heater plug retention screw
- 68 Snap ring
- 69 Stone lining
- 70 Heating muffle
- 71 Sheathed thermocouple
- 72 Seal (O-ring)
- 73 Warnings
- 74 Recess for removal of firing plate (50)
- 75 Pegs for plug-on console
- 76 Leaf spring
- 77 Plug-on console
- 78 Grounding band
- 79 Socket for Pager 1
- 80 Operating pin
- 81 Motion rod

## C = Control Unit

- 100 LC Display
- 101 Contrast key
- 102 HELP key
- 103 Foil
- 104 Function key 1
- 105 Function key 2
- 106 Function key 3
- 107 Function key 4
- 108 ESC key
- 109 ENTER key
- 110 START key
- 111 STOP key
- 112 Open furnace head key
- 113 Close furnace head key
- 114 Numerical keys (0-9)

## D = Automatic Temperature Checking Set (ATK 1)

- 121 Ceramic base block
- 122 Melting sample
- 123 Contact pins

## E = Investment Ring Cooling Grid (complete)

- 140 Investment ring cooling grid

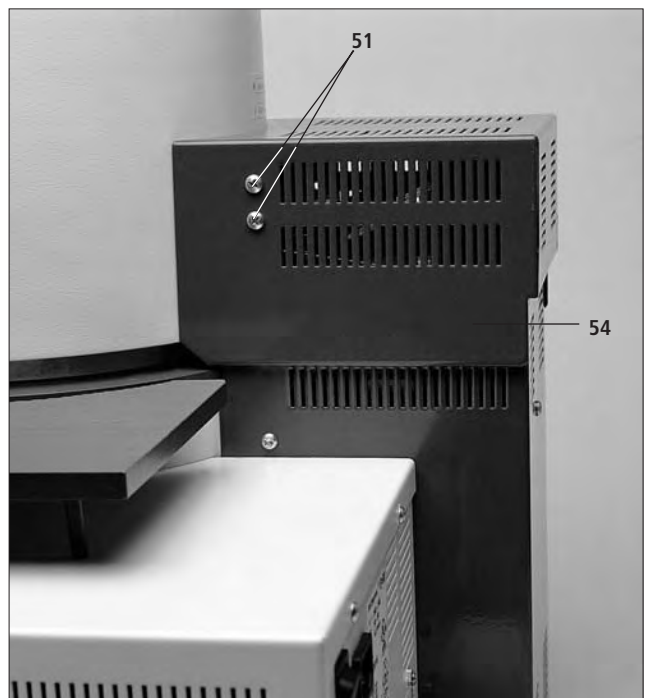
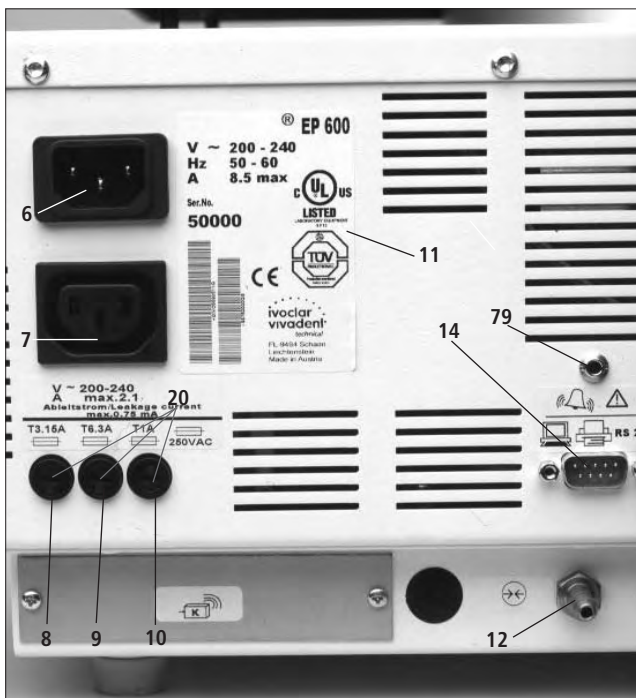
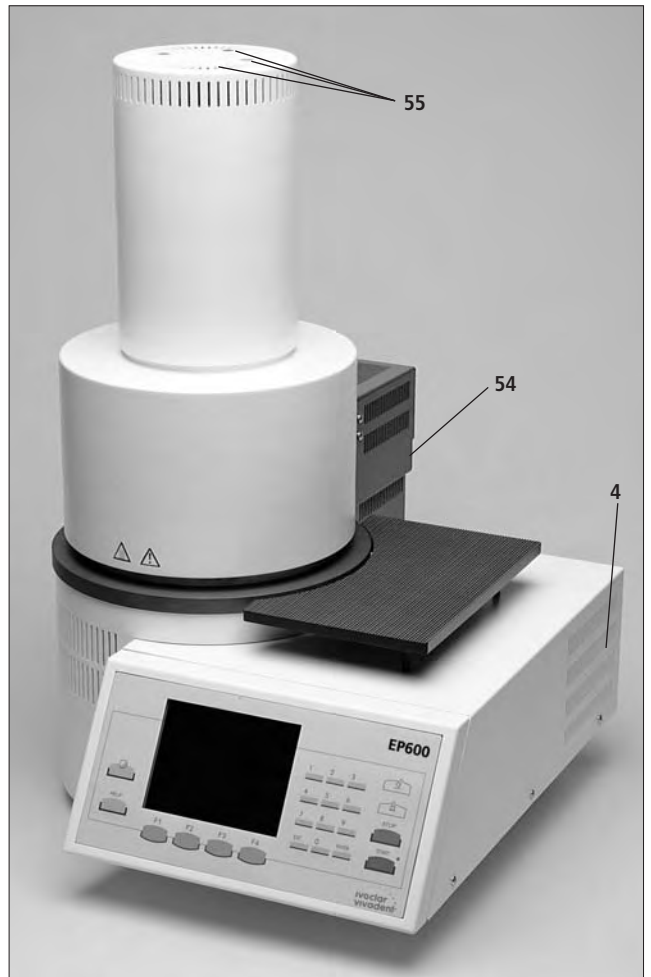
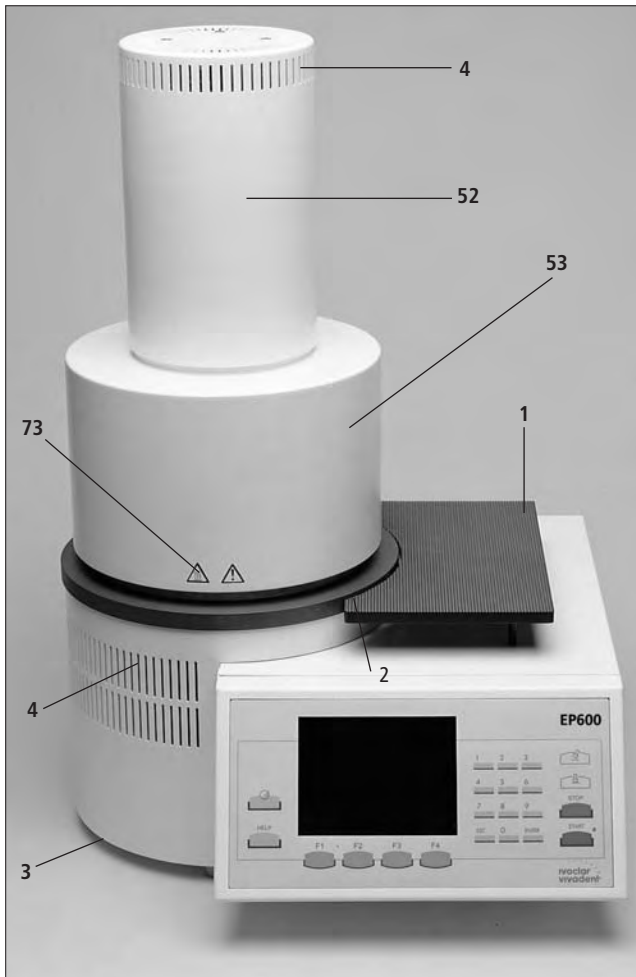

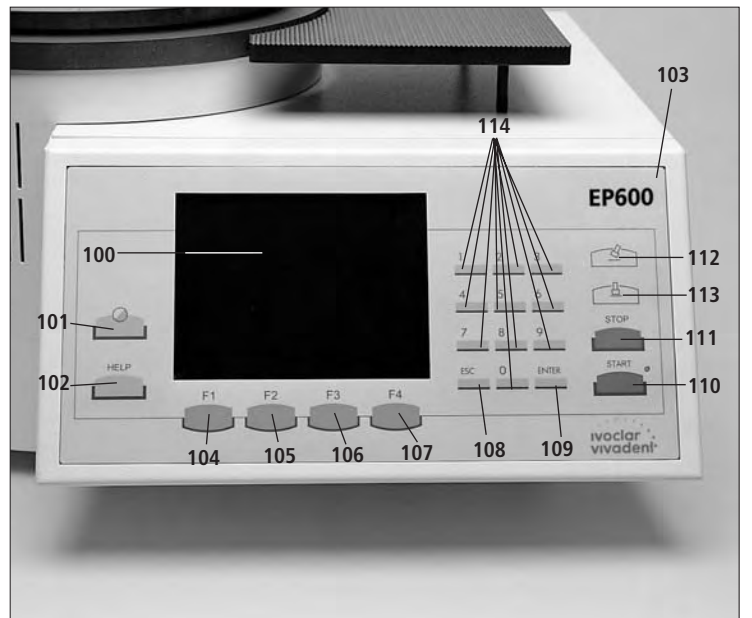
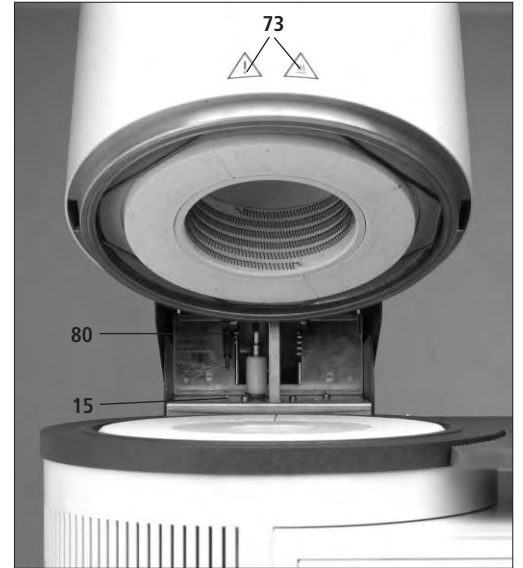
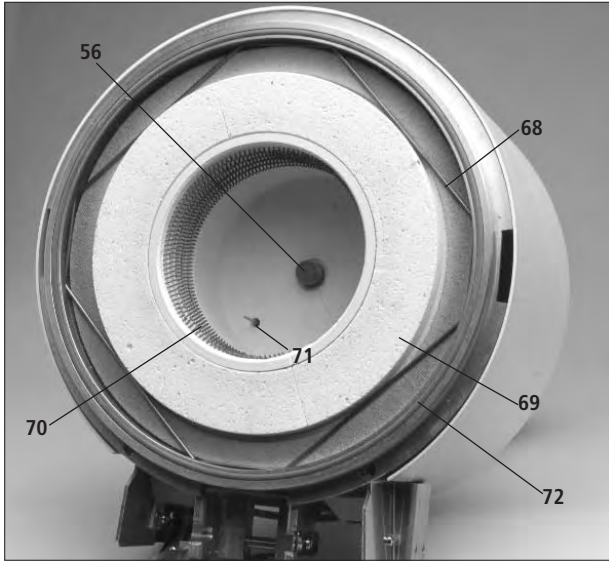
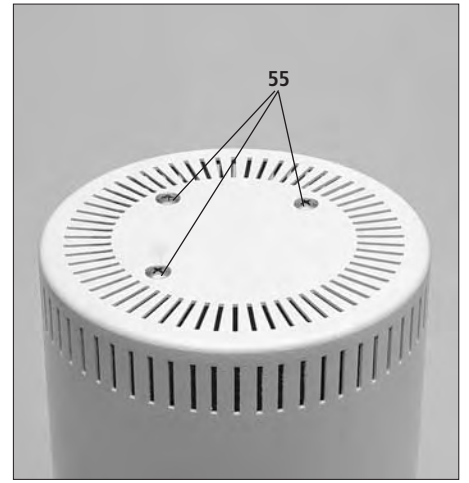
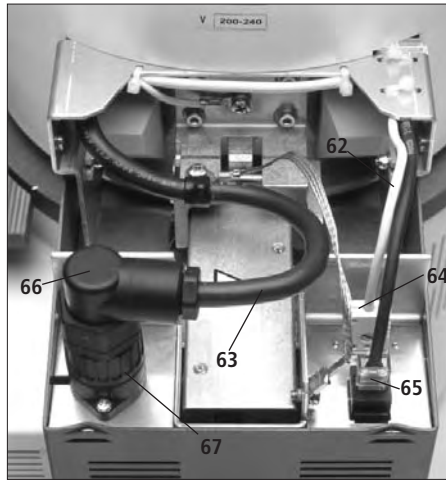
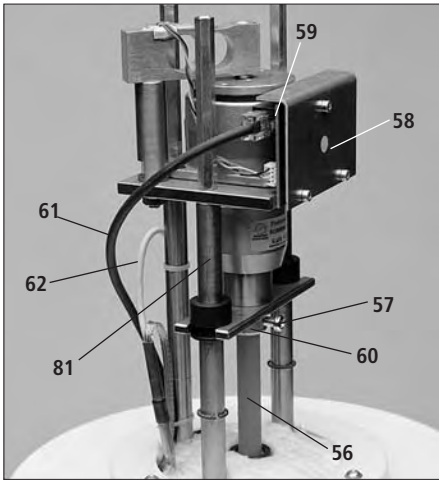

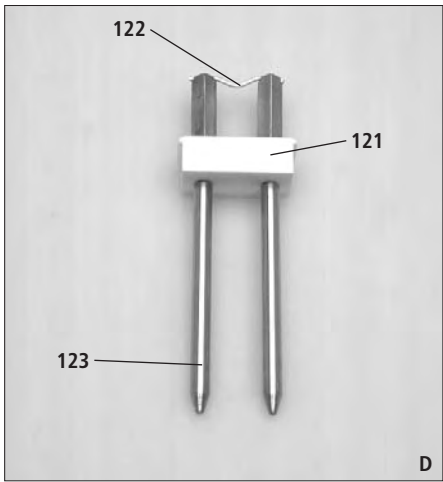
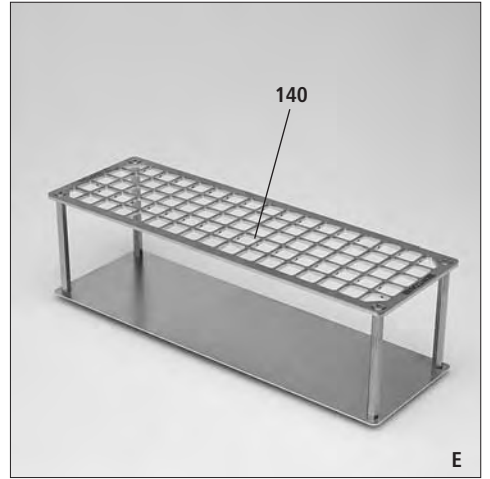
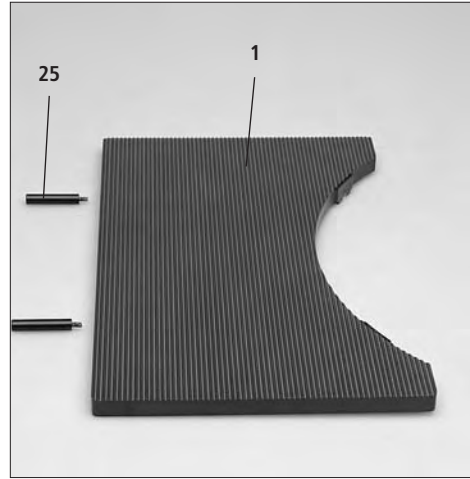
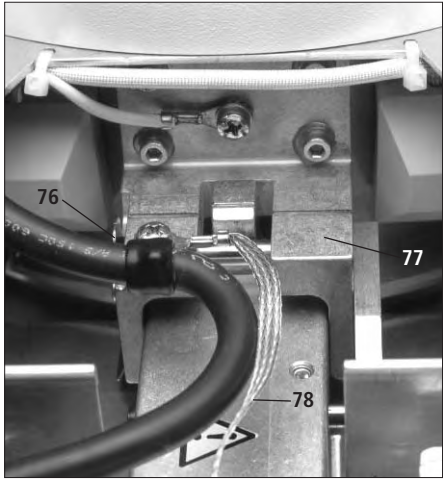
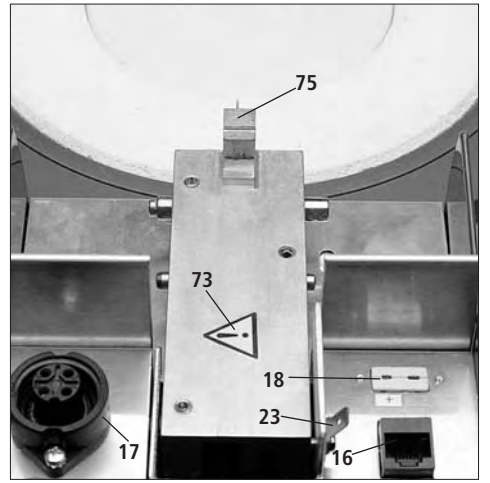
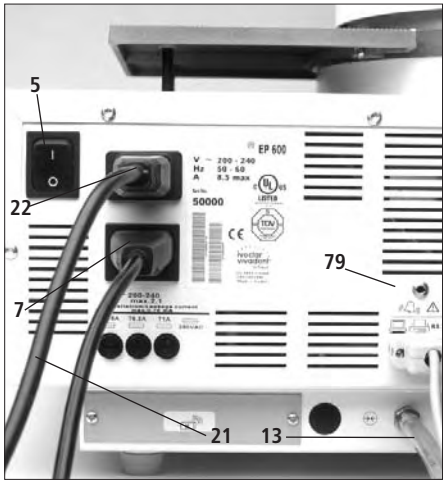

# 1. Introduction / Signs and Symbols

## 1.1 Preface

Dear Customer,  
Thank you for having purchased the EP 600 Press Furnace. This furnace with the intelligent press drive has been especially developed for the Ivoclar Vivadent all-ceramic systems (IPS e.max®, IPS Empress®). It is the latest of our technical high-quality products. Inappropriate use may damage the equipment and be harmful to personnel. Please observe the relevant safety instructions in Chapter 2.

The EP 600 is designed according to EN61010-1 and thus complies with the relevant EU regulations.

## 1.2 Signs and symbols

The signs and symbols in these Operating Instructions and on the furnace facilitate the finding of important points and have the following meanings:



### Risks and dangers

This symbol marks safety instructions that must be followed to prevent injury or death. Furthermore, damage to the furnace and/or laboratory may be avoided.



### Important information

This symbol marks additional information for correct and economic use of the EP 600.



### Contraindication



### Burn hazard



### Risk of crushing

## Furnace



### Printer

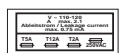

### Fuses



### Vacuum



### K-Module (Communication module)



### Alternating current (IEC 417)



### Burn hazard (IEC 417)



### Risk of crushing

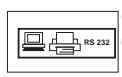

### Outlet (SELV, max. 24 VDC/A1) PC printer connection

## Display



### PRESSING Mode



### IPS e.max



### IPS Empress Esthetic



### IPS Empress Layering Technique



### IPS Empress 2 Layering Technique



### IPS Empress Cosmo



### IPS Empress Staining Technique



### Note



### Technical malfunction



### Operating error



### Saving active; do not switch off the furnace



### Timer active, programs cannot be started



### Energy-saving mode active

## 1.3 Notes regarding the Operating Instructions

These Operating Instructions facilitate the correct, safe, and economic use of the EP 600 Press Furnace. They are divided into several, clearly structured chapters. This should enable you to locate specific topics quickly and easily.



### You must read these Operating Instructions

To inform you about risks, dangers, important information, and contraindications, these Instructions contain corresponding signs/symbols to mark important paragraphs.

We recommend keeping the Instructions in a safe place near the furnace to have immediate access to the information if necessary.

Should you lose the Operating Instructions, extra copies can be ordered at a normal fee from your local Ivoclar Vivadent Service Center.

Furnace concerned:  
EP 600 Press Furnace

Target group:  
Dental technicians  
and technologists



# 2. Safety First

This chapter is especially important for individuals who work with the EP 600 or who have to carry out maintenance or repair work. This chapter must be read and the corresponding instructions followed!

## 2.1 Indications

The EP 600 has been designed for pressing IPS e.max and IPS Empress ingots and should be used for this purpose only. Uses other than the ones stipulated, e.g. cooking of food, firing of other materials, etc., are contraindicated. The manufacturer does not assume any liability for damage resulting from misuse. The user is solely responsible for any risk resulting from failure to observe these instructions.

- Further instructions to assure proper use of the furnace:
- The instructions, regulations, and notes in these Operating Instructions must be observed.
  - The instructions, regulations, and notes in the vacuum pump Operating Instructions must be observed.
  - The furnace must be operated under the indicated environmental and operating conditions (see Chapter 9)
  - The EP 600 must be properly maintained.

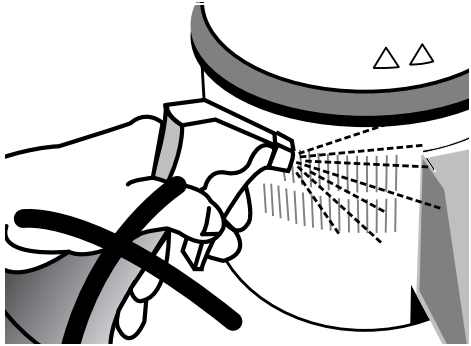

2.1.1



Risks and dangers

Make sure that no liquids or other foreign objects enter the furnace or the air vents, since this may result in an electrical shock.

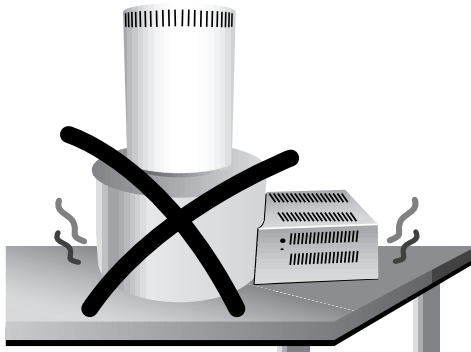

2.1.2



Burn hazard

The furnace head should not be removed from the furnace and placed on a working surface or packaging material while it is still hot, as there is a burn hazard.

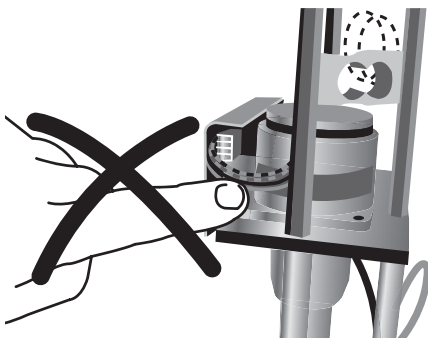

2.1.3



Risks and dangers

Never touch the electronic components, since a static discharge may damage them.



2.1.4



Risk of crushing / burn hazard

Never reach under the furnace head during operation. There is a risk of crushing and a burn hazard.

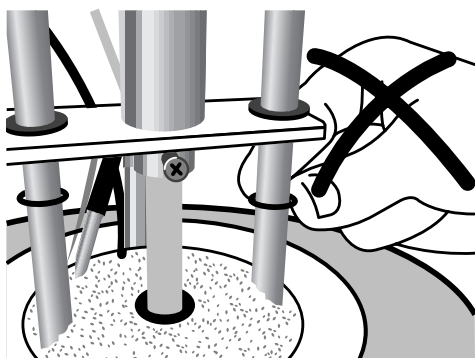

2.1.5



Risk of crushing

Never touch the press drive during operation. There is a risk of crushing.

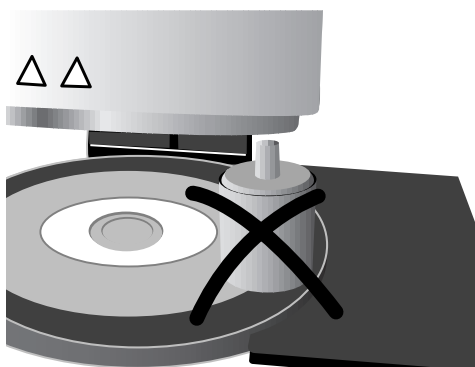

2.1.6



Contraindication

Investment rings or firing trays must not be placed in the area surrounding the firing table, since they may get stuck under the furnace head. Use the sagger tray for firing trays or the cooling grid for fired investment rings.

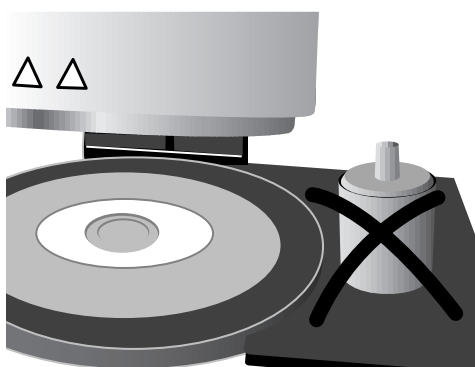

2.1.7



Contraindication

Fired investment rings must not be placed on the sagger tray to cool. Please use the cooling grid especially designed for that purpose.

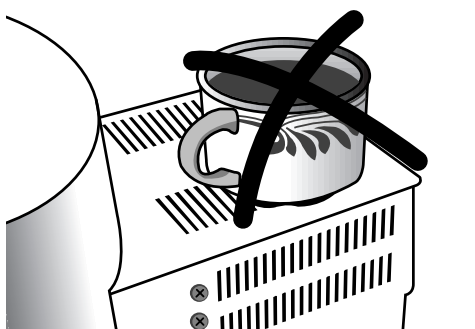

2.1.8



Contraindication

Do not place any objects on the furnace head. The opening process of the furnace head must not be obstructed.

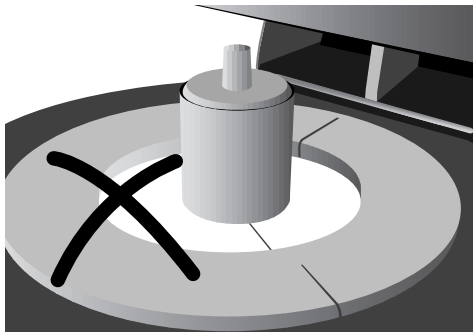

2.1.9



Contraindication

Press cycles must not be conducted without the firing plate (50) in place.



2.1.10



Contraindication

The firing plate (50) must be correctly positioned in the firing chamber.

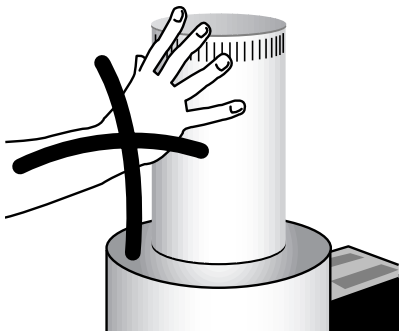

2.1.11



Contraindication

The furnace head is equipped with an electronic drive and must be operated with the corresponding keys. Never open or close the furnace head manually.

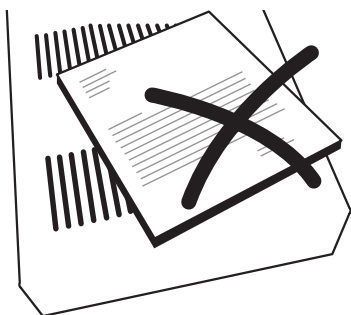

2.1.12



Contraindication

The air vents must be kept free from obstruction and clean at all times. If this is not done, there is a risk of overheating the furnace.



2.1.13



Contraindication

Do not bend the thermocouple (71). Do not touch the thermocouple with your fingers in order to prevent contamination (grease).

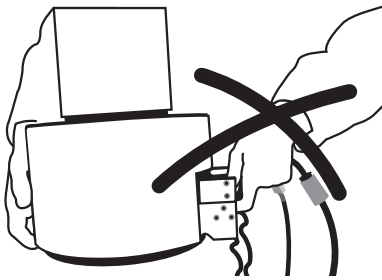

2.1.14



Contraindication

The furnace head must not be carried by holding the cables, as there is a risk of damaging the cables and the corresponding connections.

## 2.2 Health and safety instructions

This furnace has been designed according to EN 61010-1 and has been shipped from the manufacturer in safe operating condition. To maintain this condition and to ensure risk-free operation, the user must observe the notes and warnings in these Operating Instructions.

- Place furnace on a fire-proof table, observe local regulation (e.g. distance to combustible objects, etc.).
- Always keep the air vents at the rear of the furnace free from obstruction.
- Do not touch any parts that become hot during operation of the furnace.  
**There is a burn hazard.**
- Clean furnace only with a dry or slightly damp cloth. Do not use any solvents. Disconnect power before cleaning.
- Use original packaging for transportation purposes.

- It is important that the user become familiar with the warnings and operating conditions to prevent injury to personnel or damage to materials. The manufacturer is not responsible for damage resulting from misuse or failure to observe the Operating Instructions. Warranty claims cannot be accepted in such cases.
- Before switching on the furnace, make sure that the voltage indicated on the rating plate complies with the local power supply.
- The mains socket must be equipped with a residual current operated device (FI)
- The power plug may only be inserted into sockets with protected contacts.
- Before calibration, maintenance, repair, or change of parts, the power must be disconnected if the furnace has to be opened.
- If calibration, maintenance, or repair has to be carried out with the power connected and furnace open, only qualified personnel, who are familiar with the risks and dangers, may perform the procedures.
- After maintenance, the required safety tests (high voltage resistance, protective conductor, etc.) must be carried out.
- Ensure that only fuses of the indicated type and current rating are used.
- If it is assumed that safe operation is no longer possible, the power must be disconnected to avoid accidental operation. Safe operation is no longer possible if:
  - the furnace is visibly damaged
  - the furnace does not work
  - the furnace has been stored under unfavourable conditions over an extended period of time
- Use only original spare parts.
- The temperature range for faultless operation is +5 °C to + 40 °C (41 °F to 104 °F).
- If the furnace has been stored at very low temperature or high atmospheric humidity, the unit must be dried or left to adjust to the room temperature for approx. 1 hour prior to connecting power.

- The furnace is tested for use at altitudes of up to 4000 m (13,123 ft) above sea level.
- The furnace may only be used indoors.



### Risks and dangers

Do not work with liquids near the furnace. Should a liquid accidentally enter the furnace, disconnect power and consult the Customer Service. Do not operate the furnace.



### Risks and dangers

Any disruption of the protective conductor either inside or outside the furnace or any loosening of the protective conductor may lead to danger for the user in case of a malfunction. Deliberate interruptions are not tolerated. Material developing harmful gases must not be fired.

# 3. Product Description

## 3.1 Components

The EP 600 Press Furnace comprises the following components:

- Furnace base with electronic controls
- Furnace head with press drive
- Sagger tray
- Vacuum hose
- Vacuum pump with hose and power cord (accessories)

The electronic controls and the mechanical components for the opening mechanism are located in the furnace base. The heater is located in the muffle in the furnace head, where it is embedded in the stone lining segments. Operation and control of the furnace is done with state-of-the-art electronic components.

## 3.2 Hazardous areas and safety equipment

Description of the hazardous areas of the furnace:

Hazardous area	Type of risk
Press chamber	Risk of burning
Opening/closing mechanism	Risk of crushing
Electronic components	Risk of electrical shock

Description of the safety equipment of the furnace:

Safety equipment	Protective effect
Protective conductor	Protection from electrical shock
Fuses	Protection from electrical shock and damage to the furnace
Interlock switch	Protection from electrical shock

Please also refer to Chapter 2.

## 3.3 Functional description

The press chamber may be heated up to max. 1200 °C (2192 °F) by means of a heater. Furthermore, the chamber is designed so that a vacuum can be created with a vacuum pump. The press drive produces the pressure required for the press procedure. The press process is controlled by means of the electronic components and the corresponding software.

## 3.4 Accessories

- Refill Package ATK 1 "Melting Samples"
- Refill Package ATK 1 "Ceramic Base Blocks, Contact Pins"
- Vacuum pump

# 4. Installation and Initial Start-Up

## 4.1 Unpacking and checking the contents

The new packaging provides the following advantages:

- Reusable packaging
- Closing mechanism with integrated transportation grips
- Ideal protection by Styrofoam inserts
- Easy handling / optimum unpacking
- The packaging may be used in several ways (modules)

Check the delivery for completeness (see delivery form in Chapter 9) and transportation damage. If parts are damaged or missing, contact your local Ivoclar Vivadent Service Center.

Remove the furnace components from their packaging and place the unit on a suitable table. Please observe the instructions on the outer packaging.

There are no special transportation grips on the furnace. Support the bottom of the furnace to carry it.

## Packing and shipping of individual components

The packaging of the EP 600 permits simple and safe shipping of individual components. Simply use the two corresponding inserts. Fold the side flaps (2) and combine the two packaging parts by means of the transportation flaps.

The packaging may be discarded with the regular household refuse.

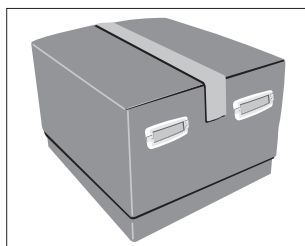
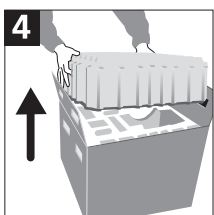
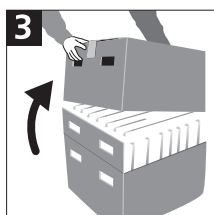
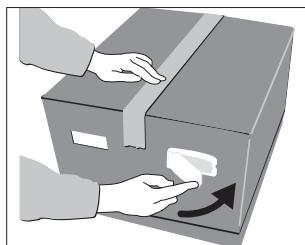
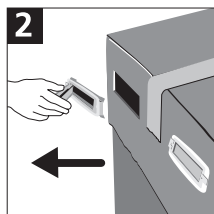
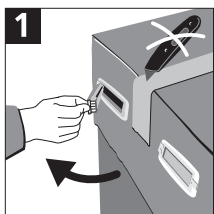
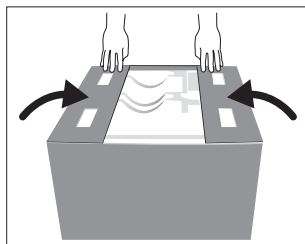
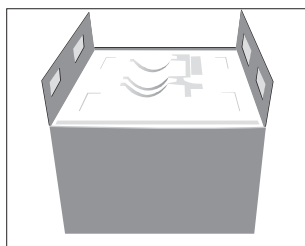

## 4.2 Selecting the location

Place the furnace on a flat table using the rubber feet. Make sure that the furnace is not placed in the immediate vicinity of heaters or other sources of heat. Furthermore, protect the furnace from direct sunlight. Make sure that air may properly circulate between the wall and the furnace.

Also ensure that there is enough space between the furnace and the user, as the furnace releases heat during the opening of the furnace head.

**The furnace should neither be placed nor operated in areas where there is an explosion hazard.**

## 4.3 Assembly and initial start-up

Make sure the voltage indicated on the rating plate complies with the local power supply. If this is not the case, the furnace must not be connected.



### Important information

We recommend keeping the original packaging for future transportation purposes. The unit has been subjected to extensive checks by the manufacturer. It may therefore exhibit slight signs of testing (hairline cracks, slight discoloration).

The furnace components are assembled as follows:

### Step 1:

#### Assembling the tray and the firing plate

- Mount the supports for the sagger tray (25)
- The sagger tray (1) is slipped onto the screws (2). If desired, the screws may be tightened using a screwdriver.
- Remove the firing plate (50) from the protective paper and place it in the stone lining.
- Clean the sealing surface (19).

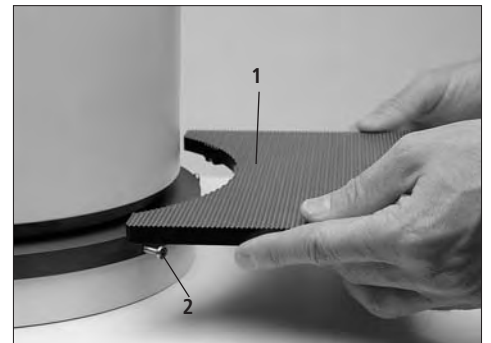

### Step 2:

#### Assembling the furnace head

The furnace head is best assembled with the rear of the furnace base placed as shown in the corresponding figure. Lift the furnace head with both hands and slip the plug-on console (77) onto the corresponding pegs (75) in the furnace base until the leaf spring (76) audibly snaps into place.



Please make sure that no cable is caught between the furnace head and the furnace base and that the red marks are lined up.



### Step 3:

#### Mounting the connections

- Connect the cables of the furnace head with the furnace base.
- Insert the heater plug (66) into the heater socket (17) and secure it with the retention screw (67) with a right-hand turn.
- Insert the thermocouple plug (64) into the thermocouple socket (18).
- Make sure the polarity of the plug is correct (+ signs together).
- Insert the press drive plug (65) into the press drive sockets (16) until it audibly snaps into place.
- Mount the grounding band (78) of the furnace head onto the slip-on tongue of the furnace base (23).

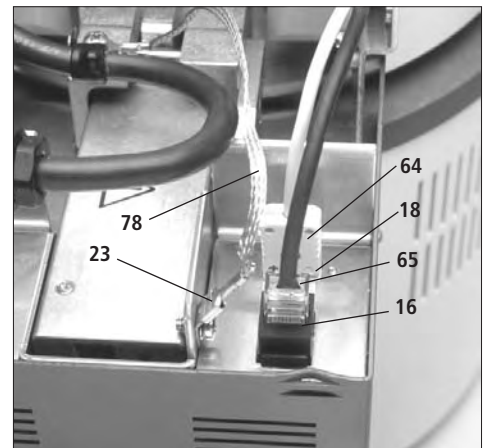
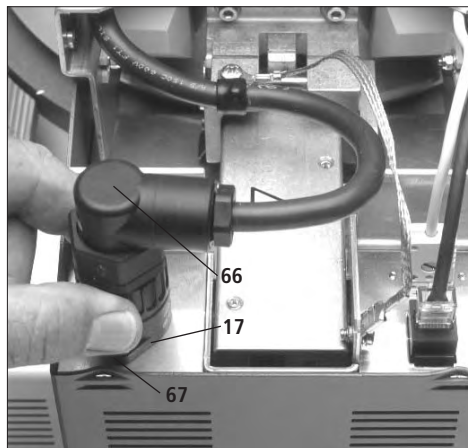

**Step 4:**

**Mounting the furnace head connections cover**

Once the connections between the furnace head and the furnace base are established, assemble the furnace head connections cover (54) and secure it with the corresponding screws (51).

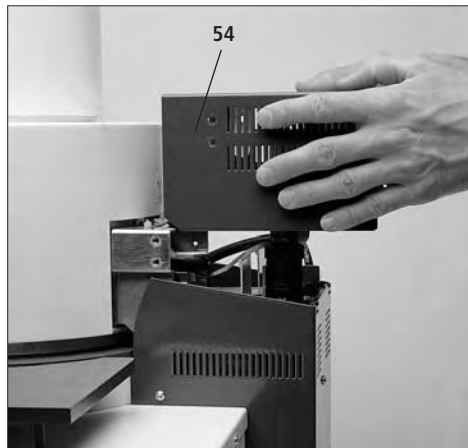

**Step 5:**

**Establishing additional connections**

Make sure the voltage indicated on the rating plate of the apparatus complies with the local power supply. If everything is in order, plug the power cord (21) into the power socket (6).

**Vacuum pump**

Insert the plug of the vacuum pump into the socket for the vacuum pump (7) and slide the vacuum hose onto the vacuum hose connection (12).



We recommend using the Ivoclar Vivadent VP3 Vacuum Pump with this furnace.

If another pump is used, the maximum power consumption and the maximum final vacuum of the corresponding pump have to be observed.

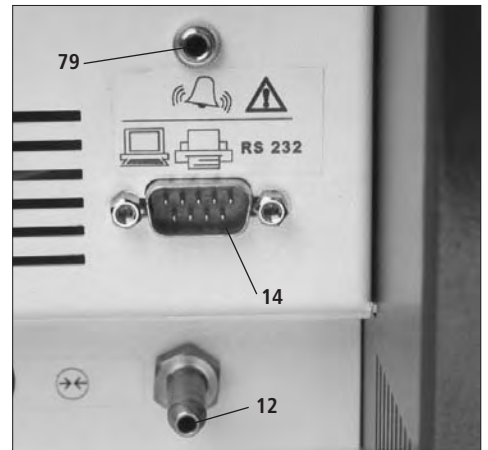
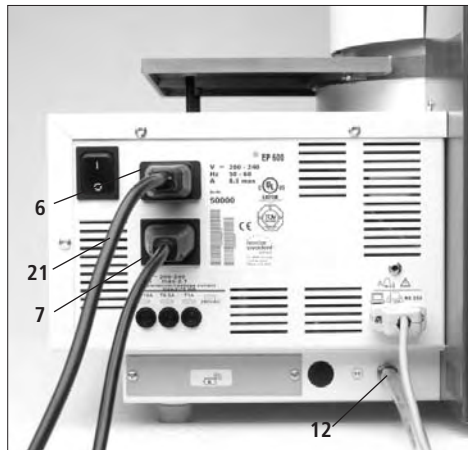

The RS232 interface (14) may also be used to connect a printer or a PC in order to save or print firing protocols.

**Step 6:**

**Setting-up the cooling grid for investment rings**

The cooling grid for investment rings is supplied fully assembled. Please position the grid in a suitable place.



Please remember that the investment rings are very hot and that the grid should not be placed on combustible surfaces or in the vicinity of combustible objects and materials.





### Initial start-up

Connect the power cord (21) with the power supply. Put the On/Off switch (5) at the rear of the furnace on position "I". The language selection menu appears on the display. Select the language by means of the F4 key and confirm by pressing ENTER. Complete the selection procedure using the function key F1. After selecting the language, the display shows the EP600 logo. After that, the unit conducts a self-test to check the basic functions. The course of the self-test is indicated by means of a status bar. Once the self-test has been completed successfully, the preheating phase will start. This phase prepares the unit for optimum temperature control. The self-test and preheating phase together usually take 30 min.

**i** To reduce the moisture in the press chamber (stone lining) the vacuum pump is switched on during the preheating phase, thus removing the moist air.

As of Software Version V3.0 the vacuum pump is kept on during the complete pre-heating phase.

Once the preheating phase has been completed, the unit is ready for operation. The 'furnace selection' menu is displayed to select whether the furnace is used as press furnace. After that, the main menu appears on the display.



### Important information

During the test of the press drive, noise from the press drive is audible (approx. 2 seconds). During the self-test, this sound is normal. If this is not the case, a technical malfunction has occurred. Please refer to Chapter 8.



The power plug may only be inserted into a grounded socket. The power cord must not come into contact with the hot furnace head and should be protected accordingly.



The EP 600 is equipped with a special electronic device that can bridge a power outage of approx. 10 seconds.



The EP 600 Press Furnace undergoes extensive checks prior to delivery. In the process, the unit is subjected to special test procedures. As a result, the firing chamber may exhibit slight signs of testing. These signs show that the unit has been tested. These checks are important for quality assurance.

### Disassembling the furnace head

Note: Before the furnace head connections cover is removed, the furnace should be switched off and the power cord (21) unplugged.

### Removing the furnace head connections cover

- Remove screws (51) of the furnace head connections cover.
- Remove the furnace head connections cover (54)

### Removing the secured furnace head

- Before the furnace head is removed, the heater plug, thermocouple plug, press drive plug, and grounding band should be disconnected from the furnace base.
- Release leaf spring (76) and lift off furnace head using both hands.



# 5. Operation and Standard Settings

## 5.1 Starting the furnace

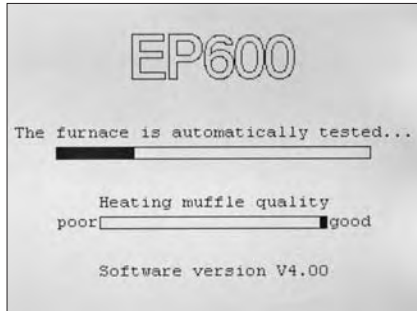

### 5.1.1 Start-up

After the furnace has been switched on, the unit undergoes a self-test, and if necessary, a preheating cycle. The furnace selection menu is shown on the display.



To reduce the moisture in the press chamber (stone lining) the vacuum pump is switched on during the pre-heating phase, thus removing the moist air.

As of Software Version V3.0 the vacuum pump is kept on during the complete pre-heating phase.

## 5.2 Introduction to the operation "Pressing"

The EP 600 is designed for use with Ivoclar Vivadent all-ceramic systems (IPS e.max, IPS Empress). Therefore, the corresponding parameters of the various programs have already been set in the factory. All you have to do is select the desired program for the corresponding material using the function keys F1 (104), F2 (105), F3 (106), or F4 (107). Next select whether you are using a large or small investment ring. After that, the display indicates the corresponding program cycle diagram. The program is started by pressing START. The firing of the press cycle selected is graphically displayed. The most important parameters are visible on the display (74) at all times.

### 5.2.1 Main menu "Pressing"

Page 1

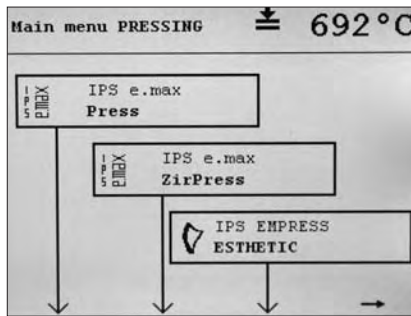

Page 2

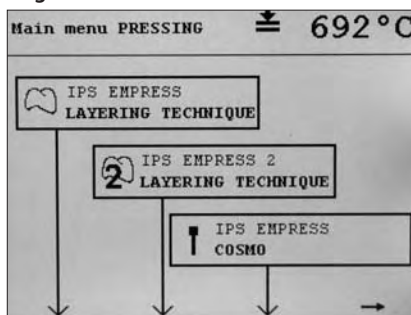

Page 3

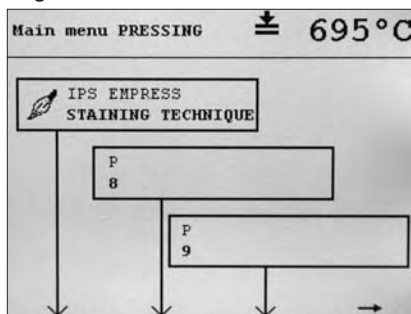

Page 4

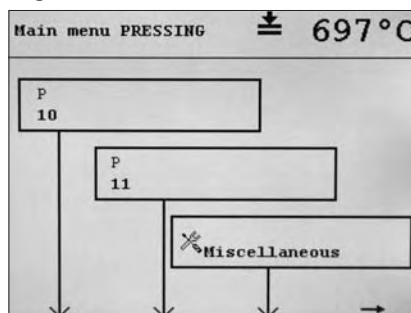

Now the press program is selected using the function keys. This menu always displays three programs, which may be selected by means of the function keys F1, F2, and F3. The menu comprises several pages. F4 is used to move forward.

On the last Page there is a menu "miscellaneous"

### 5.2.2 Menu "Investment ring selection"

This menu is used to indicate which investment ring (large, small) will be used.

### 5.2.3 Menu "Program"

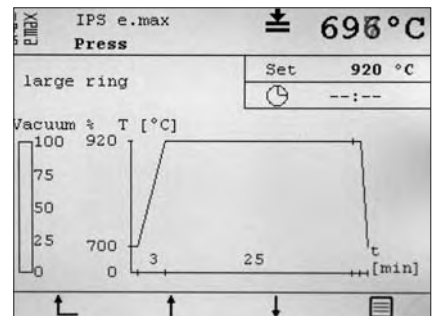

In this menu, a graphical representation of the currently selected program is displayed. The temperature curve indicates the set temperature values. The progress of the running program is shown by a bold line. The remaining time until the start of the actual press process is also indicated. As soon as the press process has commenced, the time passed since the beginning of the press process is indicated.

Furthermore, the display indicates the distance travelled by the press plunger in the selected unit of measure since the beginning of the press process, as well as the quality of the vacuum in percent. If no program is in progress, F2 and F3 can be used to change between the various programs.

With F4, the parameters of the currently selected program can be viewed (see menu "Program parameters").

### 5.2.4 Menu "Program parameters"

PROGRAM PARAMETERS		697 °C
B Stand-by temperature		700 °C
t Temperature increase		60 °C/min
T Holding temperature		920 °C
H Holding time		20 min
E Stop speed		300 um/min
Progr. name line 1		IPS EMPRESS 2
Progr. name line 2		LAYERING TECHNIQUE

In this menu, the set parameters of the selected program are displayed or edited (for freely programmable programs).

Pressing F1 returns you to the menu "Program".

### Freely programmable press programs

Furthermore, the EP 600 is equipped with 4 freely programmable press programs (P8–P11). For these programs, values within the following ranges can be entered:

Parameter	MIN	MAX	Unit of measure
B Stand-by temperature	50	900	°C
t Temperature increase	1	140	°C/min.
T Holding temperature	50	1200	°C
H Holding time	0	109	min.
E Stop speed	0	1000	µm/min



#### Important information

For the layering technique, we recommend a stop speed of 300 mm/min, for the staining technique 150 mm/min.

- Higher values (stop speed of e.g. 300 mm/min) results in the press cycle being stopped sooner.
- Lower values (stop speed of e.g. 100 mm/min) results in the press cycle being stopped later. Consequently, the press cycle is prolonged.

Once the program is started by pressing START, the new program is displayed in the usual manner.



**Please use only the original standard programs, which are especially coordinated with the corresponding materials for the Ivoclar Vivadent all-ceramic systems (IPS e.max, IPS Empress).**

### 5.3 Introduction to the menu "Miscellaneous"

This menu is called up via the main menu. It permits the selection of a number of lower-level programs with which the furnace can be configured, calibrated, tested, etc.

#### 5.3.1 Menu "Furnace information"

(Example)

Serial number of the furnace: 00001234  
 Article number of the furnace: 00006789  
 Number of press cycles: 789  
 Number of operating hours: 1245 h  
 Number of firing hours: 789 h  
 Operating hours of the vacuum pump: 367 h  
 Software date: 14.06.00  
 Version of the operating software: V01.00  
 Version of the supply board software: V01.00  
 Version of the press drive software: V01.00

#### 5.3.2 Menu "Calibration"

This menu provides an auto-calibration program. The temperature measuring circuit can only be calibrated with this program.

The data of the latest ten calibrations are stored in a table according to the date and time (see menu "Protocols").

#### 5.3.3 Menu "Diagnostic programs"

In this menu, the user is provided with various diagnostic programs (see Chapter 7.4 "Diagnostic programs").

#### 5.3.4 Menu "Interface"

With the help of this menu, the RS232 interface can be configured.

- **Baud rate**  
Defines the transmission rate.
- **Parity**  
Defines the number of bits transmitted per character.
- **Stop bits**  
Defines for which number of bits the line has to be idle before the next character is transmitted.
- **Output device**  
Selection of the type of device connected with the EP 600.
- **Code page**  
Character set

#### 5.3.5 Menu "Configuration"

In this menu, the following functions of the furnace can be configured:

##### Page 1

CONFIGURATION		± 632 °C
Furnace type	EP600	
Language	English	
Standard configuration	No	
Date format	DDMMYY	
Date	07.02.03	
Weekday	Friday	
Time	10:05:14	
Temperature unit	°C	
Vacuum unit of measure	mbar	
Unit of length	mm	

- **Furnace type**  
This option is used to select the desired furnace type: EP600 or EP 600. To change the furnace type, a code is required, which has to be entered after the selection of the new furnace type.
- **Language**  
German, English, French, Italian, Spanish. Further languages possible at a later date.
- **Default settings**  
If this option is selected and confirmed with ENTER, all the subsequent menu items are set to the default settings.
- **Date format**  
With this menu item, the date format may be changed from the European to the American format and vice versa.
- **Date**  
With this menu item, the exact date can be set.
- **Day**  
With this menu item, the day can be set.
- **Time**  
With this menu item, the exact time can be set.
- **Temperature mode**  
With this option, the temperature may be changed from °C to °F and vice versa.
- **Vacuum unit of measure**  
With this option, the unit of measure for the vacuum (mbar, hPa) can be selected and/or changed.
- **Measure of length**  
With this menu item, the measure of length (mm, inch) can be selected and/or changed.

##### Page 2

CONFIGURATION		± 701 °C
Vacuum quality 100 %	80 mbar	
Return to main menu	Yes	
Energy-saving mode	No	
Energy-saving mode time	60 min	
Acoustic signal	On	
Pitch	5	
Volume	medium	
Signal upon press start	No	
User mode	User	
Calibration value PD	670	

- **Vacuum quality 100 %**  
This option indicates the absolute value (in mbar) for 100 % vacuum quality.
- **Return to "Main menu"**  
With this option, it may be determined whether the software returns to the "Main menu" once a program is completed or if the current menu is maintained.
- **Energy saving mode**  
If the energy saving mode is active, the heat is reduced after a time period defined by the user. In this way, the life cycle of the heating muffle is prolonged and energy is saved. By pressing the indicated function key, the mode may be deactivated.
- **Time of energy saving mode**  
Period of time after which the energy saving mode is activated if no program is in progress and no key has been touched.
- **Acoustic signal**  
On/Off
- **Pitch of the signal**  
Tune 1-9
- **Volume of the signal**  
Three stages: low, medium, loud
- **Signal at the beginning of the press process**  
Yes/No
- **User mode**  
This menu option is reserved for Service Centers.
- **Press drive calibration value**

##### Page 3

CONFIGURATION		± 700 °C
Protocol active	Yes	
Pager 1	Yes	
Name of Laboratory	IVOCLAR AG	

- **Protocols active**  
No / Yes / Direct  
**No** -> Press/Firing programs are not protocolled.  
**Yes** -> Press/Firing programs are protocolled (Press/Firing program protocol table). The protocols have to be transmitted manually from the corresponding protocol table!

**Direct** → Press/Firing programs are protocolled (Press/ Firing program protocol table) and are transmitted or printed immediately on the serial interface RS232. Please note that therefore, a corresponding output device (printer or PC) has to be selected in the menu 'Interface'.

- **Pager 1**  
Yes/No
- **Laboratory name**  
Name which will appear in the header or footer of the various protocols.

### 5.3.6 Menu "Maintenance"

This menu provides the commands necessary during the maintenance of the furnace.

- Lower press plunger manually
- Lift press plunger manually

### 5.3.7 Menu "Enter new program"

The "Main menu pressing" also provides three individual programs (Program No. 5–7) in addition to the standard programs. If these programs are not shown in the menu, they are still concealed. They can be inserted using the following function:

To insert one of the programs (program No. 5–7), select this menu item (F4), type in the correct code, and confirm with ENTER.

Code	Program No.
14000	5
15000	6
16000	7

If the code was typed in correctly, the "Main menu pressing" displays the new program.



By therein entering the code, a concealed program will be released and an already released program will be concealed.

### 5.3.8 Menu "Request alarm table"

See Chapter 7.3.

### 5.3.9 Menu "Protocols"

After selecting this menu the table with the calibration data is shown.

Pos.	Calibr. value	Date	Time
0	35.9 °C	06.12.01	10:49:56
> 1	33.7 °C	11.02.03	09:40:16
9	34.8 °C	11.12.02	14:40:39
8	35.8 °C	05.11.02	16:40:44
7	17.2 °C	16.10.02	09:29:17
6	34.2 °C	24.05.02	17:16:36
5	31.1 °C	26.04.02	09:05:32
4	34.1 °C	06.03.02	14:24:16

Key F4 can be used to switch to the press program protocol table (keys to be pressed: F4, ENTER).

Pos.	Program No.	Date	Time
>> 1	9	07.05.03	09:18:40

Print position 1  
Delete table No

In this table the protocols of the last 15 press programs are stored. These protocols can be transmitted manually from here to the PC or printer (this depends on the settings in the menu 'Interface').

### 5.3.10 Menu "Timer"

In this menu, the timer may be programmed. With this feature, the furnace may be heated up to stand-by temperature or switched off at any given time.

In the interval between the switch-on and the switch-off times, the unit is kept at stand-by temperature.

To change the setting, select the corresponding switch-on/switch/off time with the cursor (F2/F3) and use the numeric keypad for selecting the desired time.

The timer can also be switched on or off with the key 'timer active-yes/no'.

The times are typically typed in via the numeric keypad. F3 is used to change the selected menu item. ESC is used to undo changes. ENTER is used to save the changes. The mains switch must not be switched off during this procedure.



When the timer is active, i.e. when the heater is switched off, the symbol ● is shown on the display. If a program has not been completely finished at the time when the furnace is scheduled to turn off, the program will nonetheless be completed before the heater is deactivated. While the timer is active, programs can only be started once the time settings have been adjusted accordingly.

## 5.4 Operating the menu / key functions

### 5.4.1 Navigation

1	CONFIGURATION	± 700°C
2	Furnace type EP600 Comb1 Language English Standard configuration No Date format DDMMYY Date 07.02.03 Weekday Friday Time 10:11:41 Temperature unit °C Vacuum unit of measure mbar Unit of length mm	
3	↑   ↑   ↓   ✓	





#### 1 Information line

This line always shows the most current temperature and operating mode. Additionally, useful program information is displayed.

#### 2 Firing curve and dialog field

In this field, the dialogues and the various information are displayed. The different parameters may be changed here.

#### 3 Function line

-  Change of level  
1 level higher
-  Selector up  
Selection within the same level
-  Selector down  
Selection within the same level
-  Change of level  
1 level lower
-  Selection key  
Selection from various possibilities  
The selection must always be confirmed with ENTER.

The four function keys below the display are used to navigate through the various menus. The functions of the keys are represented by symbols. These symbols are shown for those keys, which have a certain function at the current stage in the program. For example, the symbol for the 'page down' key is only shown if the contents of the current screen take up more than one page.

### 5.4.2 Numeric keypad

The numeric keypad is used to enter numbers. This keypad also contains the ESC and ENTER keys.

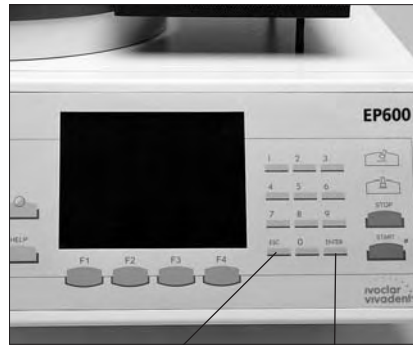

ESC:  
Discarding values

ENTER: Used to confirm entered numbers, for example, or the change of the temperature mode from °C to °F.

### 5.4.3 Text input

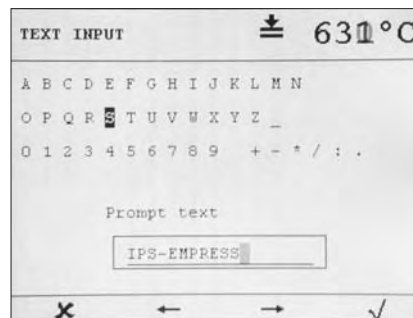

The input of text is enabled by a virtual keyboard shown on the display. F2 and F3 are used to select the characters. F4 transfers the selected, highlighted character to the text field. F1 can be used to delete a character from the text field. ENTER is used to leave the text field and confirm the text. If the user wants to quit this menu without confirming the text, ESC is used.

### 5.4.4 Numbering of the various menus

To facilitate support, each menu is given a number, which will become visible as soon as the help function of the menu in question is called up.

### 5.4.5 Display contrast

The display contrast can be regulated by means of key 101.



If the unit has been in operation for an extended period of time, the display contrast properties may change due to an increase in temperature.

## 5.5 Help function

Pressing HELP will display a help text for the current menu.

HELP	± 379°C
301	
The temperature measuring circuit of the furnace is automatically calibrated. Calibration may be conducted with the furnace hot or cold. (the condition is recognized by the furnace and taken into consideration!) Use only the ATK 1 for calibration.	
F2: Switch off acoustic signal	
↑   ↑   ↓	

If the help text consists of several pages, the 'Up' (F2) and 'Down' (F3) symbols are shown. They indicate that these keys may be used to navigate between the individual pages. F1 is used to return to the last active menu.

## 5.6 Protolling / Output of protocols

From the press/firing program protocol table the protocols stored there can be printed. For that reason use key F2 to set the cursor on position 'Print'. Subsequently, enter the position number of the protocol to be printed with the numbers' block and confirm by pressing ENTER. Using key F4 the selected protocol can be transmitted via the serial interface RS232 to the printer or PC (Prograsoft V1.3 and higher).

PROTOCOLS	± 379°C		
Protocol contents Press programs			
Pos.	Program No.	Date	Time
>> 1	9	07.05.03	09:18:40
Print position		█	
Delete table		No	
↑   ↓   →   □			

# 6. Practical Use

## 6.1 Switching on/off

Put the I/O switch at the rear of the furnace on position "I". The furnace is now switched on and the EP600 logo appears on the display. Subsequently, the unit conducts a self-test to check the basic functions. The course of the self-test is shown by means of a status bar. If the self-test does not reveal any errors or malfunctions, the preheating phase is started. The preheating phase prepares the furnace for optimum temperature control. The self-test and preheating phase together take 30 minutes. After the preheating cycle has been completed, the unit is ready for operation. The main menu appears.



### Important information

If the temperature in the firing chamber is above 300 °C (572 °F) at the time when the furnace is switched on, only a self-test is conducted. The preheating phase is not started.

## 6.2 Standard press programs

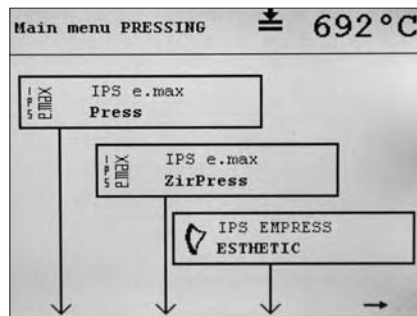

- 1 Select the desired program and type of investment ring.
- 2 Open furnace head with the corresponding key (112).
- 3 Place preheated investment ring, ingot, and Alox plunger in the furnace.
- 4 Press START; the LED of the start key lights up (the process is automatically started).
- 5 Once the press cycle has been completed, the furnace head opens automatically and the buzzer sounds. Immediately remove the investment ring from the furnace. Place it on the cooling grid to cool. The program returns to the initial position only after pressing STOP. Until that point, the press time and press cycle is shown. Close the furnace by pressing 'Close furnace head'.



### Important information

Please use the separate cooling grid and not the sagger tray of the furnace.



### Important information for the IPS e.max and Empress System

Various examinations have shown that the time taken to remove the investment ring from the preheating furnace and to place it in the press furnace significantly influences the press results.

This process should not take more than 1 minute. If it takes longer, the investment ring will cool down too much and miscasts may result.

In addition, make sure to open the furnace head only immediately before placing the investment rings in the furnace to prevent the firing chamber (heater, stone lining, and in particular the firing plate) from cooling down too much.

# 7. Maintenance, Cleaning, Diagnosis

This chapter describes the maintenance and cleaning procedures that may be performed by the users. All other tasks must be performed by qualified service personnel at a certified Ivoclar Vivadent Service Center.

## 7.1 Monitoring and maintenance

The time for these maintenance procedures depends on the frequency of use and the working habits of the users. For that reason, the recommended times are only approximates.



Turn off the furnace and disconnect power before maintenance and cleaning, since there is a risk of electrical shock.



This apparatus has been developed for typical use in the dental laboratory.

If the product is used in a production facility, for industrial applications, or in continuous firing operation, premature ageing of certain spare parts have to be expected.

These spare parts are e.g.:

- Heating muffle
- Insulation material
- Lamps

These spare parts are not covered by the warranty.

Please also observe the shorter service and maintenance intervals.

What	Part	When
Check all plug-in connections for correct fit	Various external connections	weekly
Check if the furnace head opens smoothly and without excessive noise	Furnace head opening mechanism	monthly
Check if the thermocouple is straight and in the right place	Thermocouple	weekly
Check the stone lining inserts for large cracks or damage. If the stone linings are worn down, they must be replaced by a certified Ivoclar Vivadent Service Center. Slight hairline cracks on the stone lining surface do not have a negative influence.	Stone lining inserts	weekly
Check if the sealing rims of the furnace head and furnace base are clean and undamaged	Sealing rims of the furnace head and furnace base	weekly
Check the keypad for visible damage. If the keypad is damaged, it must be replaced by a certified Ivoclar Vivadent Service Center.	Keypad	weekly
Check furnace temperature (calibration).	Press chamber	After 50 press cycles.

## 7.2 Cleaning



The furnace may only be cleaned when it is cool, since there is a burn hazard. Do not use any cleaning solutions.

Parts	Frequency	Cleaning material
Housing	if required	soft, dry cloth
Keypad	weekly, or if required	soft, dry cloth
Tray	if required	cleaning brush or vacuum cleaner
Stone lining inserts	daily	cleaning brush
Sealing rims of the furnace head and furnace base	daily	cleaning brush and a soft cloth



### 7.3 Menu "Access alarm table"

In this menu, up to 20 of the last alarm messages are listed in a table. In case of inquiries, please provide the service technician with this information.



The enclosed error list contains further information.

### 7.4 Menu "Diagnostic programs"

#### – Vacuum and system test

The program checks the final value (in mbar) that the vacuum reaches after a defined period of time and how much time passes until 50 mbar are reached.

#### – Muffle test

By measuring the maximum power consumption of the heating muffle, the 'age' of the heating muffle is determined and presented by a bar diagram. If the muffle has a high power consumption (good, new), the bar is solid. At a certain stage, the user is informed that the heating muffle has to be replaced shortly.

#### – Keypad test

If the user conducts this test, all the keys are represented on the display by a matching symbol. Pressing the corresponding key results in the symbol of the display being inverted to change to non-inverted (depending on the actual condition).



F1 is not represented, since this key is used to quit the menu.

#### – Display test

The test merely presents a certain pattern (e.g. chessboard pattern: inverted / non-inverted) so that the user may check for defective pixels.

#### – Press drive test

Automatic check of the press drive. Possible malfunctions are pointed out.

### 7.5 Temperature calibration

The accuracy of the thermocouple changes during use. In order for it to function optimally, it needs to be recalibrated on a regular basis. The automatic furnace calibration set (Automatic Temperature Checking Set 1) has been especially developed for this purpose. We recommend that you check your furnace with the Automatic Temperature Checking Set 1 after 50 press cycles. The corresponding message will be displayed. Calibration should be conducted while the furnace is at operating temperature (stand-by temperature). It takes approx. 2 hours. For that reason, we recommend that you calibrate the furnace overnight in order to save time.

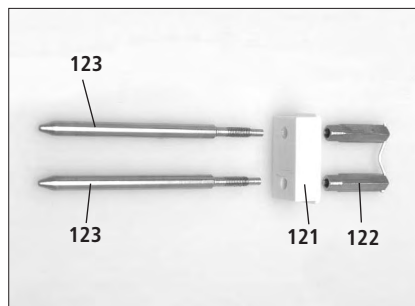

1. Insert the melting sample (122) in the ceramic base block (121).



2. Screw the sample (122) to the contact pins (123).



#### Important

Do not use tongs. Tighten until barely fingertight.

3. Go to "Miscellaneous" and select calibration program. Now the furnace head opens.

4. Remove the firing plate (50) from the furnace with the firing tongs and place it on the sagger tray.

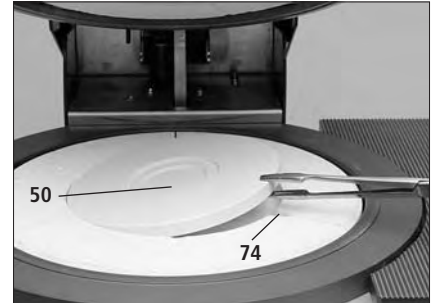

5. Use tongs to insert the completed test assembly into the recesses for the ATK 1 (124).

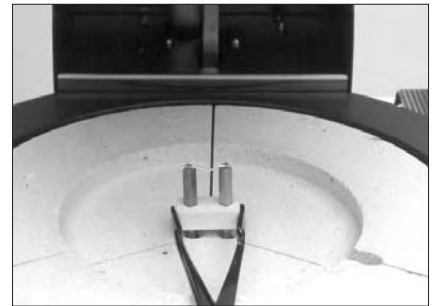

6. Place the tongs at the center of the test assembly and press lightly until it perceptibly clicks into place.

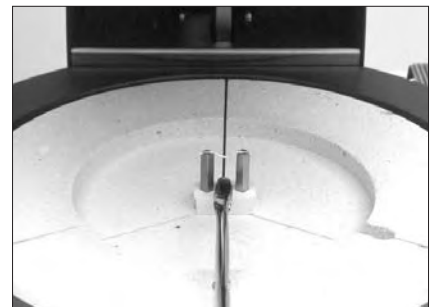

7. Start the calibration program.

8. At the end of the program, remove the test assembly from the furnace using the tongs and allow it to cool.



#### Contraindication

Under no circumstances should you pull on the test sample. The ceramic base will break as a consequence.

9. Replace the firing plate (50) and select a firing program. The furnace head will close automatically.

10. Once the sample assembly has cooled, take it apart.

11. Use new melting samples for the next calibration procedure and begin with step 1.

## 7.6 Changing the press plunger

In order to facilitate the changing of the press plunger, we recommend lowering the press plunger manually by using the corresponding option in the menu "Maintenance".

1. Remove the screws (55) and the press drive cover (52) while the furnace head is closed.

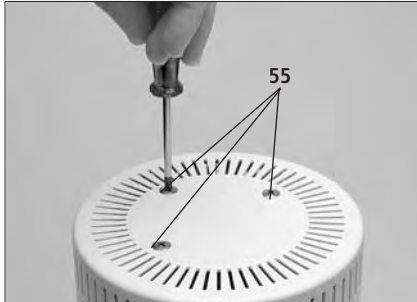

2. Loosen the terminal screw (57) for the press plunger with approx. half a turn.
3. Open the furnace head with the corresponding key (112). Once the furnace head is completely open, switch off the furnace, disconnect the power, and allow the furnace to cool to room temperature.

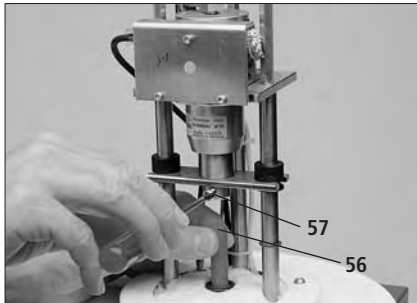

4. Move the press plunger (56) into the firing chamber by pushing it with one hand and pulling it with the other while rotating it slightly.



### Contraindication

Take care not to buckle the thermocouple located in the upper part of the firing chamber.

5. Insert the new press plunger (56) with the red mark into the guide bush with the phasing (inclination) first. Push the plunger into its split taper socket (6) by rotating it slightly. Tighten the screw (57).

6. Reconnect power and switch on the furnace with the I/O switch.



Never reach into the press drive during operation. There is a risk of crushing.

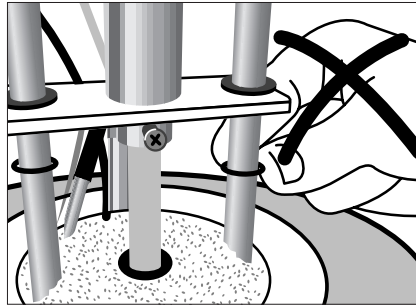

Wait until the furnace head closes automatically. Remount the press drive cover (52) and tighten the corresponding screws.

# 8. What If...

This chapter will help you to recognize malfunctions and take the appropriate measures or, if possible, to perform minor repairs.

## 8.1 Error messages and notifications (alarm)

Alarm notifications are directly displayed and can be classified as follows:



**8.1.1 Technical errors**  
(The furnace has noticed a technical defect.)



**8.1.2 Operating errors**  
(The user has tried to make an incorrect entry.)



**8.1.3 Notifications**  
Helpful information.

### 8.1.1 Technical errors

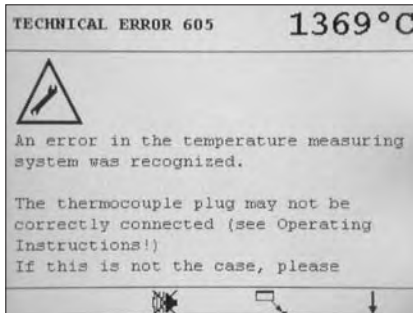

In case of a technical malfunction, a corresponding message is displayed and an alarm signal sounds. The alarm signal can be switched off by pressing F2.

As long as the malfunction is active, the "Minimize" symbol (F3) is indicated, otherwise the "Acknowledge" symbol (F1) is shown.

Depending on which symbol is shown, the error message has to be minimized to a symbol by pressing F3 (see "Minimized error messages") or acknowledged with F1 after it has been read.

### Minimized error messages

If an error message is minimized, a corresponding symbol  will appear next to the temperature indicator.

If the error is still active after two minutes, the alarm window will appear again and the corresponding signal will sound.

### 8.1.2 Operating errors

In case of an operating error (incorrect data entry, etc.) an operating error message is displayed, which has to be acknowledged with F1.

### 8.1.3 Notifications

In special cases, notifications are displayed, which will provide you with important information. The notifications also have to be acknowledged with F1.

## 8.2 Technical malfunctions

These malfunctions may occur without an error message being displayed:

Description	Double-Check	Action
<b>Vacuum is not or only slowly released</b>	Is the vacuum released within approx. 30 seconds?	Wait until the vacuum has been released and remove object. Switch the furnace off and on again. If it is still not working, contact your local Ivoclar Vivadent Service Center.
<b>Microswitch of the furnace head opening mechanism does not engage</b>	Is the opening for the operating pin (item 15 in parts list) obstructed?	Remove dirt (foreign objects) from the opening.
<b>The calibration sample assembly cannot be properly inserted</b>	Is the recess obstructed by a foreign object?	Clean the recess with a vacuum cleaner. The EP600 should be cold for that purpose.
<b>Loud noises in the press drive</b>	Is the press plunger (56) dirty or damaged?	Clean press plunger or replace it, if necessary
	Are the motion rods (81) of the press mechanism dirty?	Clean motion rods with a dry cloth. Do not apply grease.
<b>Display incomplete</b>		Run the display test program and contact your local Ivoclar Vivadent Service Center, if necessary.
<b>Text on the display is difficult to read</b>	Is the contrast set correctly?	Press "Contrast" key (101) until the contrast is ideal.
<b>Display is not illuminated</b>	Is the fuse (10) for the electronic controls OK?	Check fuse and replace it, if necessary.
<b>Buzzer does not sound</b>	Is the buzzer switched off (tune 0)?	Select tune (1–9)
<b>Furnace head does not open</b>	Is the fuse (10) OK?	Check fuse and replace it, if necessary.
	Was the furnace head opened manually?	Use only the corresponding key to open the furnace head. Switch furnace off and on again.
	Has the vacuum been released?	Is the program still running? Wait until the program is completed. Switch furnace off and on again. If it still does not work, contact your local Ivoclar Vivadent Service Center.
<b>Press plunger fractured in the area of the terminal screw</b>	Was the terminal screw of the press plunger (57) screwed too tightly?	Replace defective press plunger.
<b>Press plunger slips out of its holder</b>	Is the press plunger correctly secured?	Tighten the terminal screw of the press plunger (57).
<b>Press plunger is too long</b>	Was the press plunger of the EP500 with a length of 200 mm accidentally used?	Use the red press plunger designed for the EP 600 (175 mm).
<b>Vacuum pump does not start working</b>	Is the fuse for the vacuum pump (8) defective?	Check fuse and replace it, if necessary.
	Was the max. power consumption (2.2 A) surpassed?	Use only the vacuum pump recommended by Ivoclar Vivadent.
	Is the vacuum pump plug correctly inserted?	Correctly connect the vacuum pump plug with the furnace base.

Description	Double-Check	Action
<b>Final vacuum is not reached</b>	Is the vacuum hose OK?	Check vacuum hose (13) and hose connection.
	Was the absolute value for the vacuum set incorrectly or not in accordance with the pump capacity?	Set a lower absolute value in the menu "Configuration" (Chapter 5.4.5)
	Is the furnace airtight?	Clean sealing surfaces.
	Is the press plunger OK, and in place?	Make sure that the press plunger is mounted and not fractured.
	Is the pump capacity accurate?	Run vacuum test program.
<b>Wrong or illogical temperature indication</b>	Is the thermocouple (71) buckled or fractured?	Contact your local Ivoclar Vivadent Service Center.
	Is the plug for the thermocouple correctly inserted?	Insert the plug correctly.
	Is the plug for the thermocouple defective?	Contact your local Ivoclar Vivadent Service Center.
<b>Cracks in the heating muffle</b>	Are the cracks small and neglectable (hairline cracks)?	Small cracks in the muffle are normal and do not negatively influence the performance of the furnace.
	Are the cracks very large or are parts of the muffle broken off?	Contact your local Ivoclar Vivadent Service Center.

#### List of Errors

These Operating Instructions also contain a list of errors that may be displayed by the corresponding EP 600 software.



Use only fuses and original spare parts from Ivoclar Vivadent with the corresponding test labels.



The contrast (brightness) of the display may slightly change after long periods of operation.

### 8.3 Repair

Repairs may only be carried out by a certified Ivoclar Vivadent Service Center. Please refer to the addresses listed on page 36. If repairs during the warranty period are not carried out by a certified Ivoclar Vivadent Service Center, the warranty will expire immediately.

Please also read the safety instructions in Chapter 2.

# 9. Product Specification

This chapter contains all the relevant product specifications.

## 9.1 Delivery form

### EP 600

- EP 600 incl. software
- Sagger tray
- Automatic Temperature Checking Set 1 (complete)
- Investment ring cooling grid
- Power cord
- Vacuum hose
- Operating Instructions
- Firing plate (slit)

### Accessories

- Refill package ATK1 "Melting Samples"
- Refill package ATK 1 " Ceramic Base Block"
- VP3 Vacuum Pump

### Colours

#### Standard colour:

Traffic white (RAL 9016)

#### Special colours:

- Salmon (RAL 3014)
- Aquamarine (RAL 5014)
- Turquoise (RAL 6027)

## 9.2 Technical data

<b>Power supply:</b>	200–240 Volt, 50–60 Hz 110–120 Volt, 50–60 Hz Installation category II
<b>Max. power consumption:</b>	12 A at 110–120 VAC 8,5 A at 200–240 VAC
<b>Vacuum quality:</b>	100% 40–120 mbar
<b>Acceptable data for pumps of other manufacturers:</b>	Max. power consumption: 2,1 A Final vacuum: < 50 mbar Use only tested pumps!
<b>Electrical fuses:</b>	200–240V: T 6,3 A (heating circuit) T 1 A (controls) T3,15 A (vacuum pump) 110–120V: T 12 A (heating circuit) T 2 A (controls) T5 A (vacuum pump)
<b>Fuse dimensions:</b>	200–240V = diameter 5 x 20 mm 110–120V = diameter 6,3 x 32 mm
<b>Dimensions:</b>	w x d x h: 445 x 520 x 650 mm
<b>Usable size of the press chamber:</b>	diameter 50 mm, height 85 mm
<b>Max. press temperature:</b>	1200 °C
<b>Weights:</b>	Furnace head: 7,6 kg Furnace base: 17,0 kg Tray: 0,4 kg Press furnace, complete: 25,0 kg Extra muffle: 0,3 kg
<b>Safety information:</b>	IEC 1010-1, EN 61010-2-020, Part 1 ULC and cUL standards
<b>Radio protection, electromagnetic compatibility:</b>	EMC tested



### 9.3 Acceptable operating conditions

- **Acceptable temperature range:**  
+5 °C to +40 °C  
(+41 °F to +104 °F)
- **Acceptable humidity range**  
Maximum relative humidity 80 % for temperatures up to 31 °C (87.8 °F), gradually decreasing to 50 % relative humidity at 40 °C (104 °F).  
Condensation excluded.
- **Acceptable ambient pressure**  
The furnace is tested for use at altitudes of up to 4000 m (13,123 ft) above sea level.  
Atmospheric pressure 500 mbar – 1060 mbar.



#### **Important information**

If condensation water or ice is formed after unpacking, we recommend allowing the furnace to dry at room temperature for at least 24 hours.



**Do not connect power cord. Even if the furnace seems to be dry on the outside, humidity may still be present inside.**

**Use only the original power cord for operation.**

### 9.4 Acceptable transportation and storage conditions

- **Acceptable temperature range**  
-20 °C to +50 °C  
(-4 °F to +122 °F)
- **Acceptable humidity range**  
Max. relative humidity 80 %
- **Acceptable ambient pressure**  
500 mbar – 1060 mbar

Use only the original packaging together with the corresponding foam material for shipping purposes.

# 10. Miscellaneous

## 10.1 Press table

Program	Description	Investment ring size
1	IPS e.max Press	large
	IPS e.max Press	small
2	IPS e.max ZirPress	large
	IPS e.max ZirPress	small
3	IPS Empress Esthetic	large
	IPS Empress Esthetic	small
4	IPS Empress Layering Technique	large
	IPS Empress Layering Technique	small
5	IPS Empress 2 Layering Technique	large
	IPS Empress 2 Layering Technique	small
6	IPS Empress Cosmo	large
	IPS Empress Cosmo	small
7	IPS Empress Staining Technique	large
	IPS Empress Staining Technique	small
8	Reserve	large
	Reserve	small
9	Reserve	large
	Reserve	small
10	Reserve	large
	Reserve	small
11	Reserve	large
	Reserve	small



The program parameters are set in the factory. The parameters used may differ, but they are based on the latest standard of technology of the Research & Development Department of Ivoclar Vivadent, Schaan.

For each of the listed programs, either the option "small" or "large" investment ring must be selected.



The program numbers for the reserve programs (8–11) are indicated on the new furnaces which are delivered ex works as of Software Version V.4.0.

If the Software Version V.4.0 has not been installed ex works and the furnace has been upgraded with an update version, the program numbers 6 and 7 will be occupied with standard programs. The parameters existing in the programs 6 and 7 will not be maintained.



10.2 Menu structure of the EP 600

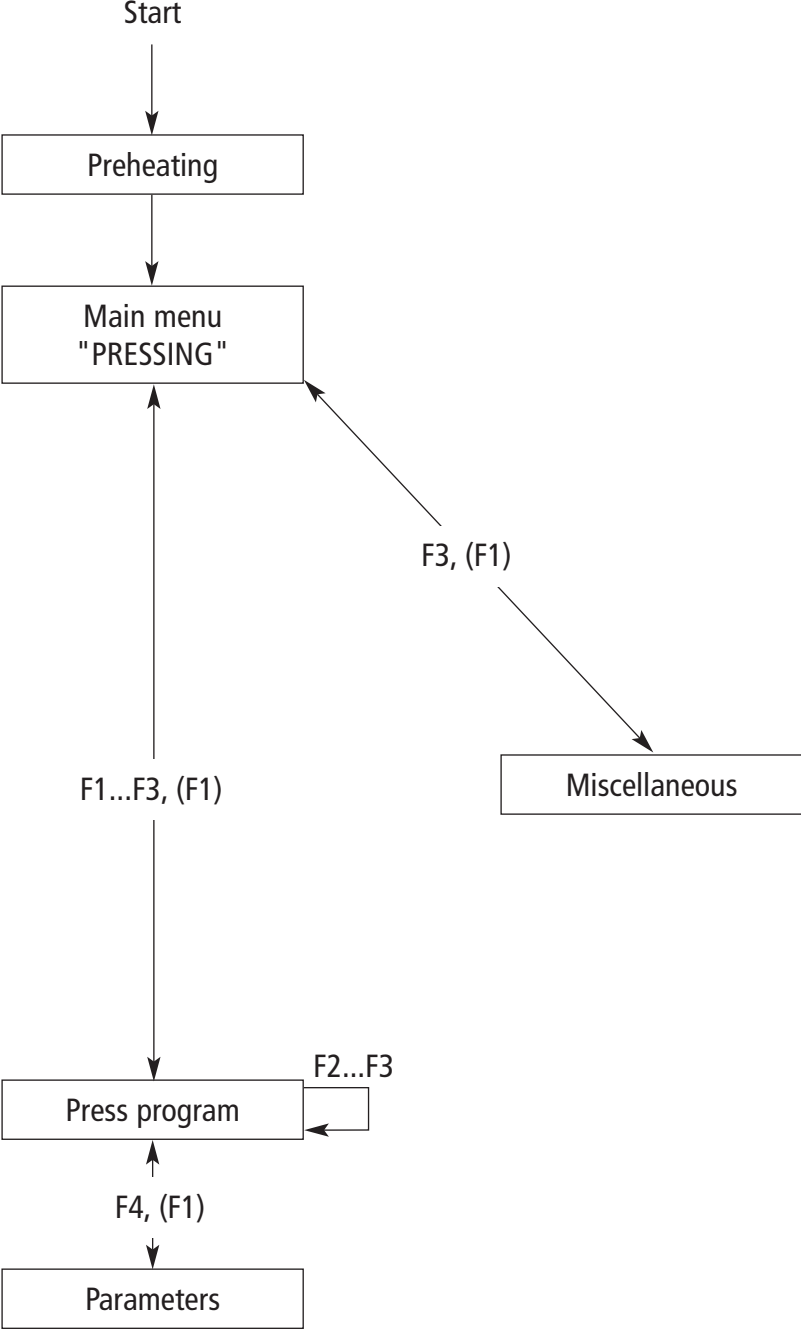

Description:



F1... skip into the next menu below with F1  
 (F3)... skip back with F3





# Ivoclar Vivadent – worldwide

## **Ivoclar Vivadent AG**

Bendererstrasse 2  
FL-9494 Schaan  
Liechtenstein  
Tel. +423 235 35 35  
Fax +423 235 33 60  
www.ivoclarvivadent.com

## **Ivoclar Vivadent Pty. Ltd.**

1 – 5 Overseas Drive  
P.O. Box 367  
Noble Park, Vic. 3174  
Australia  
Tel. +61 3 979 595 99  
Fax +61 3 979 596 45  
www.ivoclarvivadent.com.au

## **Ivoclar Vivadent GmbH**

Bremschstr. 16  
Postfach 223  
A-6706 Bürs  
Austria  
Tel. +43 5552 624 49  
Fax +43 5552 675 15  
www.ivoclarvivadent.com

## **Ivoclar Vivadent Ltda.**

Rua Maestro João Gomes de  
Araújo 50; Salas 92/94  
Sao Paulo, CEP 02332-020  
Brazil  
Tel. +55 11 69 59 89 77  
Fax +55 11 69 71 17 50  
www.ivoclarvivadent.com

## **Ivoclar Vivadent Inc.**

2785 Skymark Avenue, Unit 1  
Mississauga  
Ontario L4W 4Y3  
Canada  
Tel. +1 905 238 57 00  
Fax +1 905 238 5711  
www.ivoclarvivadent.us.com

## **Ivoclar Vivadent Marketing Ltd.**

Rm 603 Kuen Yang  
International Business Plaza  
No. 798 Zhao Jia Bang Road  
Shanghai 200030  
China  
Tel. +86 21 5456 0776  
Fax. +86 21 6445 1561  
www.ivoclarvivadent.com

## **Ivoclar Vivadent Marketing Ltd.**

Calle 134 No. 13-83, Of. 520  
Bogotá  
Colombia  
Tel. +57 1 627 33 99  
Fax +57 1 633 16 63  
www.ivoclarvivadent.com

## **Ivoclar Vivadent SAS**

B.P. 118  
F-74410 Saint-Jorioz  
France  
Tel. +33 450 88 64 00  
Fax +33 450 68 91 52  
www.ivoclarvivadent.fr

## **Ivoclar Vivadent GmbH**

Dr. Adolf-Schneider-Str. 2  
D-73479 Ellwangen, Jagst  
Germany  
Tel. +49 (0) 79 61 / 8 89-0  
Fax +49 (0) 79 61 / 63 26  
www.ivoclarvivadent.de

## **Ivoclar Vivadent Marketing Ltd**

114, Janki Centre  
Shah Industrial Estate  
Veera Desai Road,  
Andheri (West)  
Mumbai 400 053  
India  
Tel. +91 (22) 673 0302  
Fax. +91 (22) 673 0301  
www.ivoclarvivadent.firm.in

## **Ivoclar Vivadent s.r.l.**

Via dell'Industria 16  
I-39025 Naturno (BZ)  
Italy  
Tel. +39 0473 67 01 11  
Fax +39 0473 66 77 80  
www.ivoclarvivadent.it

## **Ivoclar Vivadent S.A. de C.V.**

Av. Mazatlán No. 61, Piso 2  
Col. Condesa  
06170 México, D.F.  
Mexico  
Tel. +52 (55) 5062-1000  
Fax +52 (55) 5553 1426  
www.ivoclarvivadent.com.mx

## **Ivoclar Vivadent Ltd**

12 Omega St, Albany  
PO Box 5243 Wellesley St  
Auckland, New Zealand  
Tel. +64 9 914 9999  
Fax +64 9 630 61 48  
www.ivoclarvivadent.co.nz

## **Ivoclar Vivadent Polska Sp. z o.o.**

ul. Jana Pawła II 78  
PL-01-501 Warszawa  
Poland  
Tel. +48 22 635 54 96  
Fax +48 22 635 54 69  
www.ivoclarvivadent.pl

## **Ivoclar Vivadent S.A.**

c/Emilio Muñoz, 15  
Esquina c/Albarracín  
E-28037 Madrid  
Spain  
Tel. + 34 91 375 78 20  
Fax + 34 91 375 78 38  
www.ivoclarvivadent.com

## **Ivoclar Vivadent AB**

Dalvägen 14  
S-169 56 Solna  
Sweden  
Tel. +46 8 514 93 943  
Fax +46 8 514 93 940  
www.ivoclarvivadent.se

## **Ivoclar Vivadent UK Limited**

Ground Floor Compass Building  
Feldspar Close  
Warrens Business Park  
Enderby  
Leicester LE19 4SE  
United Kingdom  
Tel. +44 116 284 78 80  
Fax +44 116 284 78 81  
www.ivoclarvivadent.co.uk

## **Ivoclar Vivadent, Inc.**

175 Pineview Drive  
Amherst, N.Y. 14228  
USA  
Tel. +1 800 533 6825  
Fax +1 716 691 2285  
www.ivoclarvivadent.us.com

**Version: 8**

**Issued: 06/2005**

**For software V4.0**

This apparatus has been developed solely for use in dentistry. Start-up and operation should be done strictly according to the Operating Instructions. Liability cannot be accepted for damages resulting from misuse or failure to observe the Instructions. The user is solely responsible for testing the apparatus for its suitability for any purpose not explicitly stated in the Instructions. Descriptions and data constitute no warranty of attributes and are not binding.

Printed in Liechtenstein  
© Ivoclar Vivadent AG, Schaan/Liechtenstein  
559608/0605/e

**ivoclar**  
**vivadent-**  
technical