

Programat® CS



Operating Instructions

Valid as of
Software Version 3.0

CE

ivoclar
vivadent®

Table of Contents

Views of the Furnace, List of Parts	4
1. Introduction / Signs and Symbols	8
1.1 Preface	
1.2 Introduction	
1.3 Notes regarding the Operating Instructions	
1.4 Notes on the different voltage versions	
2. Safety First	9
2.1 Indications	
2.2 Health and safety instructions	
3. Product Description	12
3.1 Components	
3.2 Hazardous areas and safety equipment	
3.3 Functional description	
3.4 Accessories	
3.5 Indication/Contraindication	
4. Installation and Initial Start-Up	13
4.1 Unpacking and checking the contents	
4.2 Selecting the location	
4.3 Assembly	
4.4 Dismounting the furnace head	
4.5 Initial start-up	
5. Operation and Configuration	18
5.1 Introduction to the operation	
5.2 Explanation of the key functions	
5.3 Basic meaning of the display information	
5.4 Program structure	
5.5 Adjustable parameters and possible value ranges	
5.6 Settings / test programs and information	
5.7 Explanation of the symbols on the display	
5.8 Explanation of the beeper signals	
6. Practical Use	23
6.1 Switching on/off	
6.2 Firing using a standard program	
6.3 Firing using an individual program	
6.4 Other options and special features of the furnace	
6.5 Programming	
7. Maintenance, Cleaning and Diagnosis	25
7.1 Monitoring and maintenance	
7.2 Cleaning	
7.3 Diagnosis program	
8. What if ...	27
8.1 Error messages	
8.2 Additional error messages	
8.3 Technical malfunctions	
8.4 Repair	
9. Product Specifications	30
9.1 Delivery form	
9.2 Technical data	
9.3 Acceptable operating conditions	
9.4 Acceptable transportation and storage conditions	
10. Appendix	31
10.1 Program table	
10.2 Program structure	

List of Parts

Front view:

- 1 Sealing surface
- 2 Furnace head sealing ring
- 3 Insulation
- 4 Thermocouple
- 5 Firing plate
- 6 Display
- 7 Frame plate
- 8 QTK heating muffle
- 9 Furnace housing
- 10 Keypad
- 11 On/Off switch
- 12 Heating element fuse
- 13 Vacuum pump fuse
- 14 USB-Device interface
- 15 Fuse holder
- 16 Power cord
- 17 Power socket
- 18 Vacuum pump socket
- 19 Rating plate
- 20 Thermocouple cable
- 21 Vacuum hose connection
- 23 Rubber feet
- 24 Firing plate holder
- 25 Furnace head housing
- 26 Thermocouple plug
- 27 Plug fuse
- 28 Heater plug
- 29 Heater plug socket
- 30 Thermocouple plug socket
- 32 Leaf spring
- 33 Air vents (base)
- 34 Cooling tray
- 35 Screw for cooling tray
- 36 Hood
- 37 Knurled screw for hood
- 38 Air vents furnace head
- 39 Air vents rear panel
- 40 Warnings
- 41 Furnace head mounting mark
- 42 Furnace base mounting mark
- 43 Furnace head mounting
- 44 Quartz-glass tube
- 46 Vacuum hose
- 47 Silicone rest
- 48 Connecting rod
- 49 Plug-in console

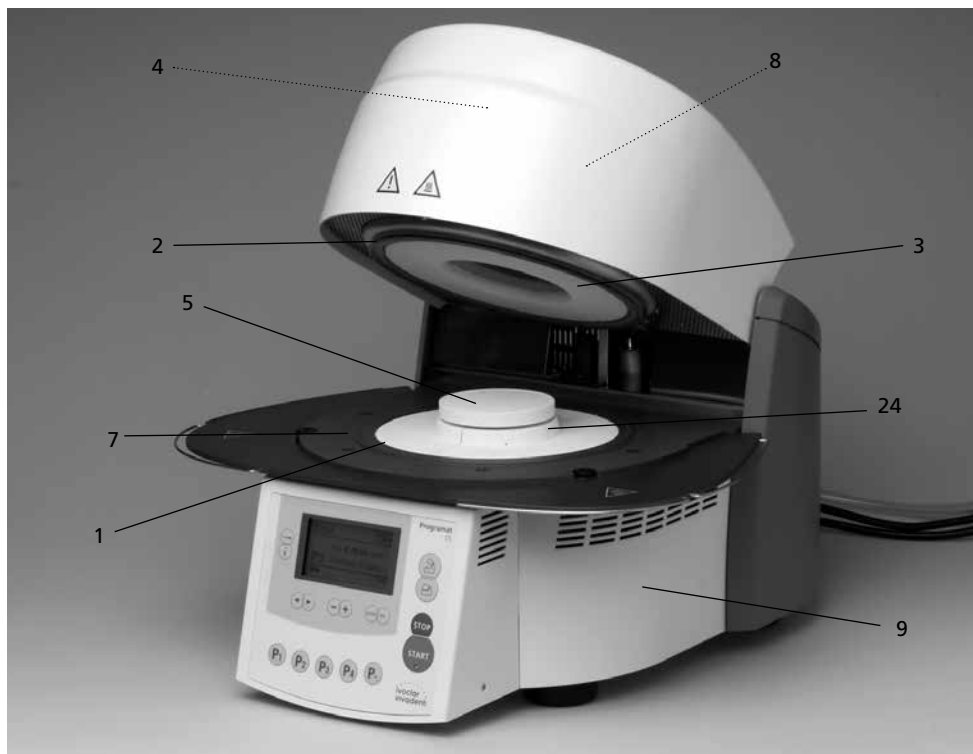
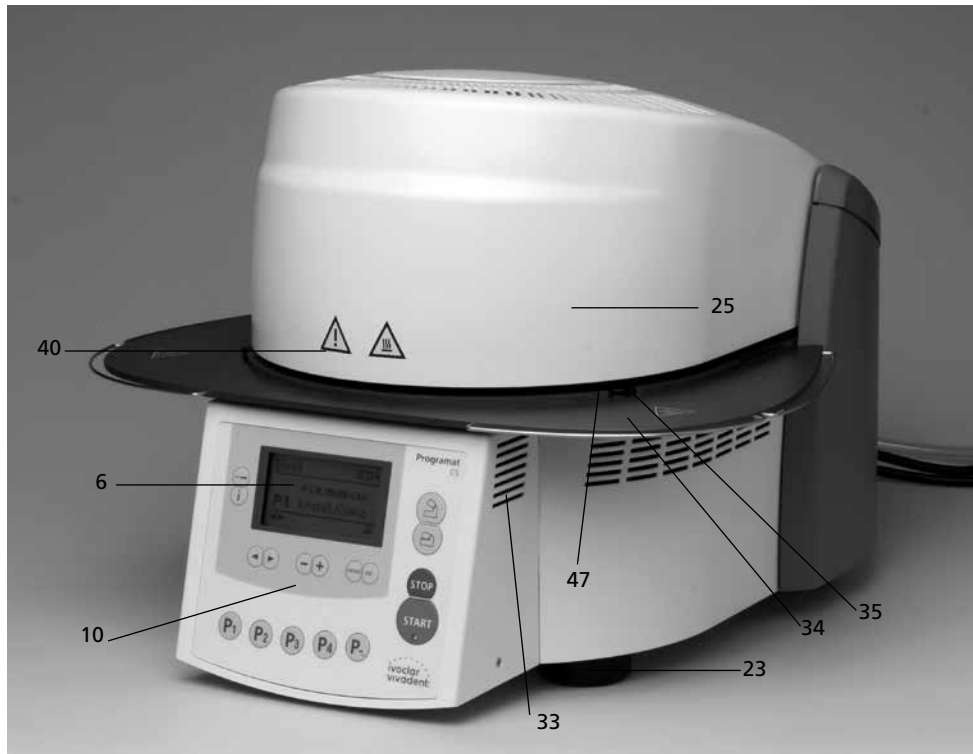

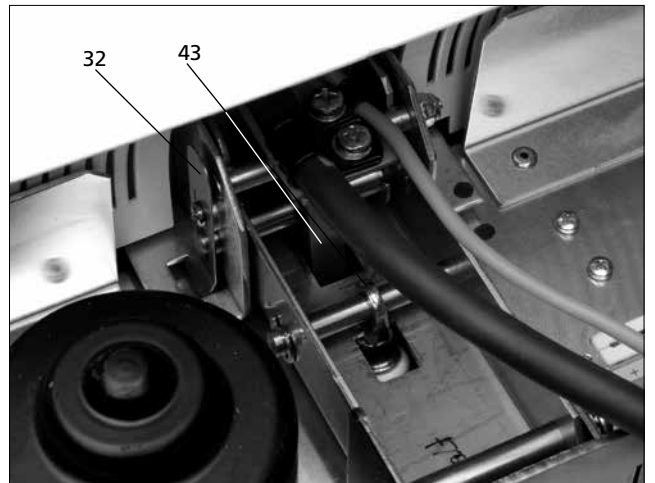
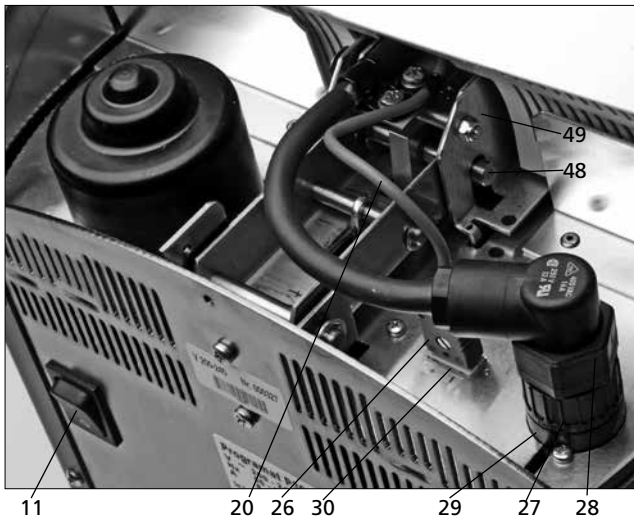
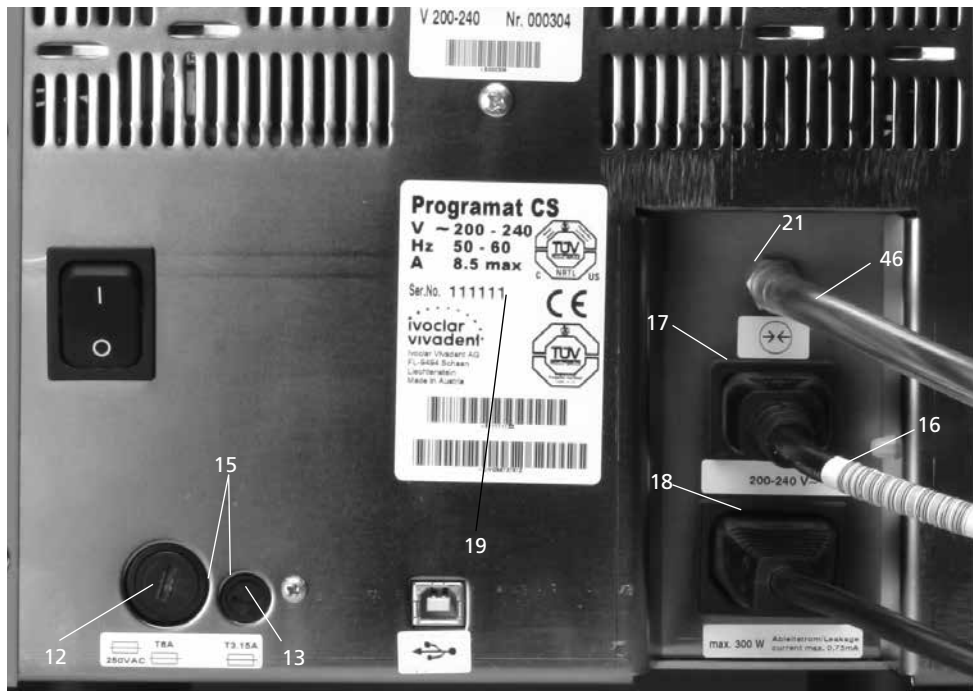
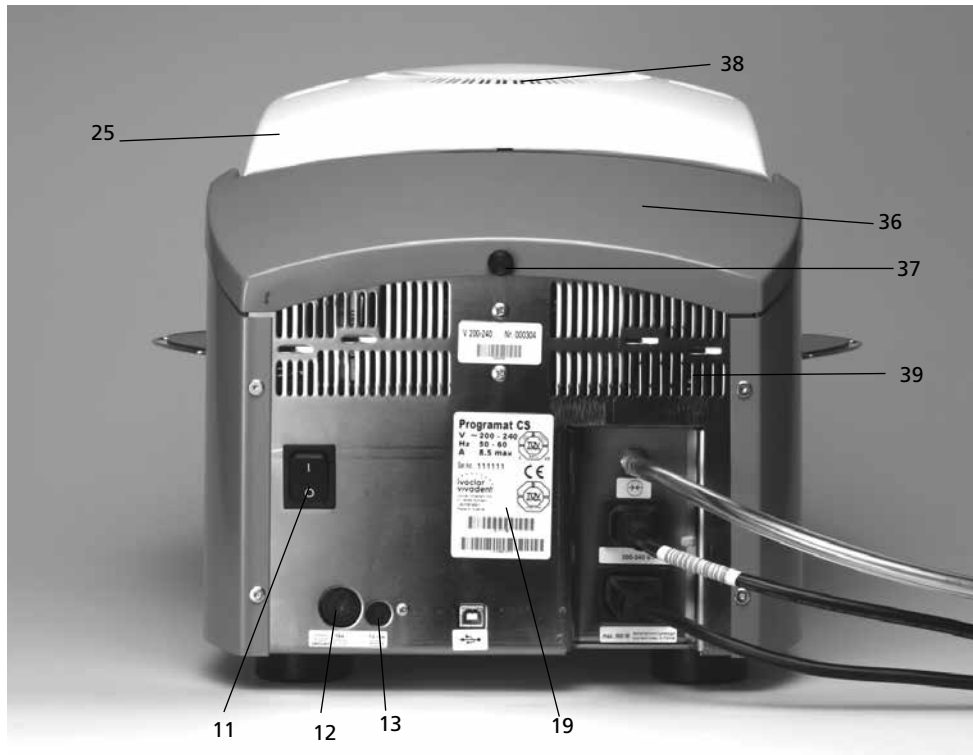

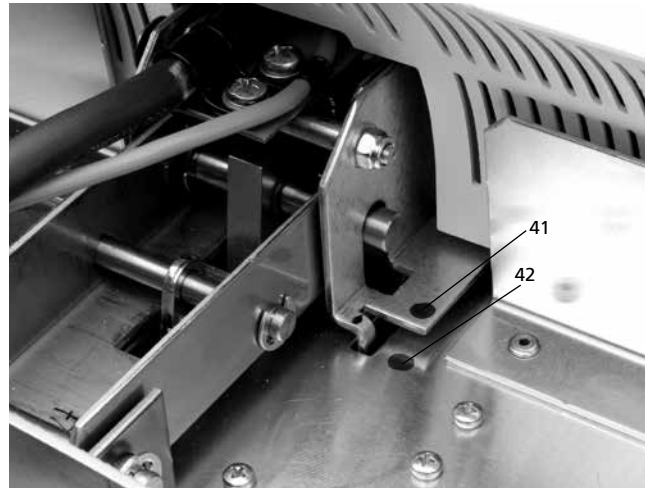
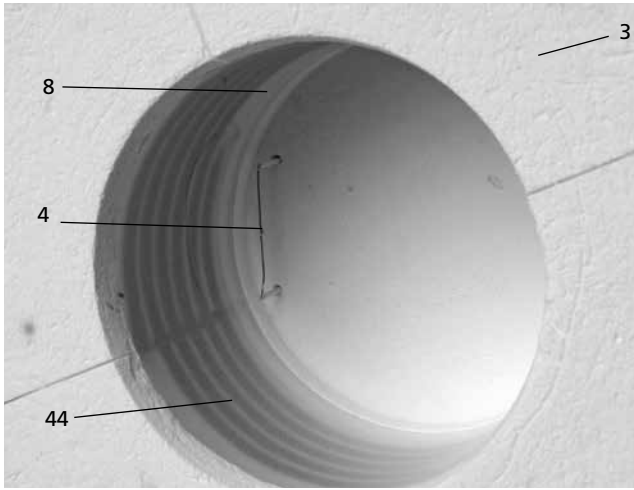

Control unit:

- 71 ESC key
- 72 ENTER key
- 73 START key
- 74 Start LED
- 75 STOP key
- 76 + key
- 77 - key
- 78 Settings key
- 79 Cursor key right
- 80 Cursor key left
- 81 Information key
- 82 Program 1
- 83 Program 2
- 84 Program 3
- 85 Program 4
- 86 Next program
- 87 Open furnace head
- 88 Close furnace head

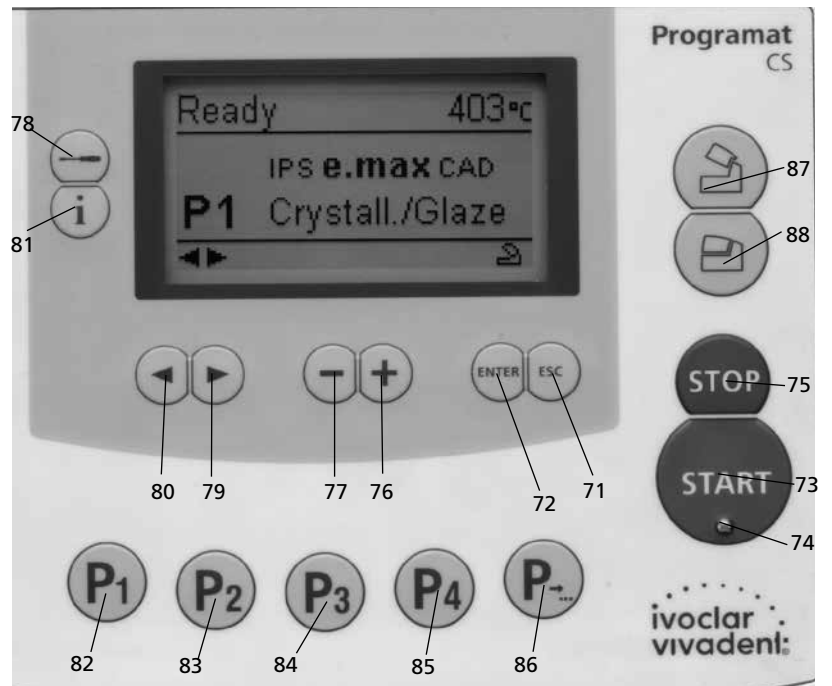

- 100 Programat firing tray
- 101 Metal pin A
- 102 Metal pin B
- 103 Metal pin C

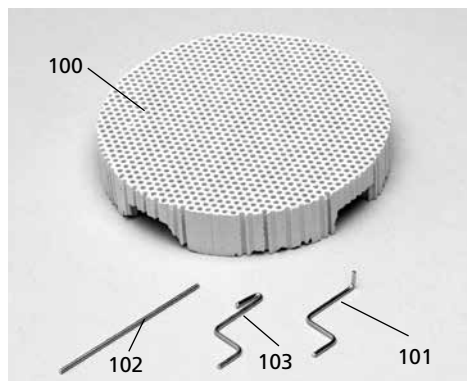

1. Introduction / Signs and Symbols

1.1 Preface

Dear Customer

Thank you for having purchased the Programat CS. It is a state-of-the-art furnace for the dental practice, which requires a furnace for the CAD/CAM technique. The Programat CS enables glaze and crystallization firings for the CAD/CAM technology. This furnace has been specially developed for this purpose.

The furnace has been designed according to the latest industry standards. Inappropriate use may damage the equipment and be harmful to personnel. Please observe the relevant safety instructions and read these Operating Instructions carefully.

Enjoy working with the CS.

1.2 Introduction

The signs and symbols in these Operating Instructions facilitate the finding of important points and have the following meanings:



Risks and dangers



Important information



Contraindication



Burn hazard



Risk of crushing



The Operating Instructions must be read

1.3 Notes regarding the Operating Instructions



Furnace concerned:
Programat CS
Target group:
Dentists and dental technologists

These Operating Instructions facilitate the correct, safe, and economic use of the Programat CS furnace.

Should you lose the Operating Instructions, extra copies can be ordered at a nominal fee from your local Ivoclar Vivadent Service Center or downloaded from www.ivoclarvivadent.com/downloadcenter.

1.4 Notes on the different voltage versions

The furnace is available with different voltage versions.

- 100 V / 50–60 Hz
- 110–120 V / 50–60 Hz
- 200–240 V / 50–60 Hz

In the Operating Instructions, the furnace is described in the 200-240 V voltage version.

Please note that the voltage range shown on the images (e.g. rating plate) may differ depending on the voltage version of your furnace

2. Safety First

This chapter is especially important for personnel who work with the Programat CS or who have to carry out maintenance or repair work. This chapter must be read and the corresponding instructions followed.

2.1 Indications

The Programat CS must only be used to fire dental ceramic materials and it should be used for this purpose only. Other uses than the ones stipulated, e.g. cooking of food, firing of other materials, etc. are contraindicated. The manufacturer does not assume any liability for damage resulting from misuse. The user is solely responsible for any risk resulting from failure to observe these Instructions.

Further instructions to assure proper use of the furnace:

- The instructions, regulations, and notes in these Operating Instructions must be observed.
- The instructions, regulations, and notes in the material's Instructions for Use must be observed.
- The furnace must be operated under the indicated environmental and operating conditions (Chapter 9).
- The Programat CS must be properly maintained.

2.1.1



Contraindication

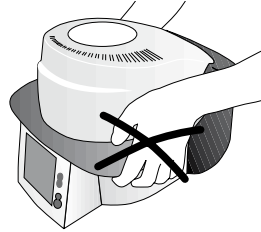

Do not carry the furnace head by the cooling tray.

2.1.2



Contraindication

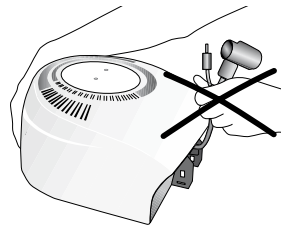

Do not carry the furnace head by the cables, since the cables and connections may be damaged.

2.1.3



Contraindication

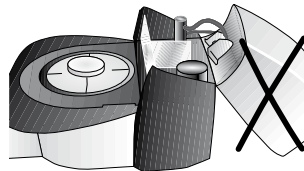

The furnace head should not be removed from the furnace base as long as the furnace head is connected by means of the heater cable.

2.1.4



Contraindication

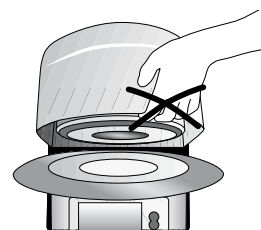

The furnace has an electric drive and must be operated by means of the electronic controls. Never open the furnace head by hand, since the mechanism will be damaged.

2.1.5



Contraindication

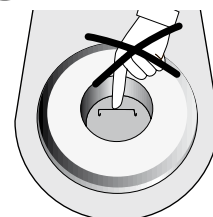

Do not touch the thermocouple and the quartz tube in the firing chamber. Avoid contact with the skin (grease contamination), as the parts will be prematurely damaged.

2.1.6



Contraindication

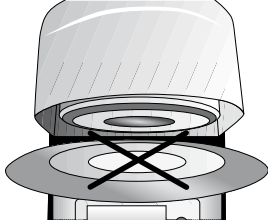

Never use the furnace without a firing table.

2.1.7



Contraindication

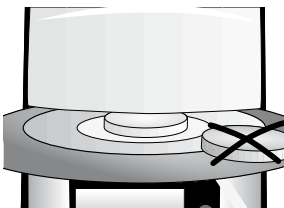

Firing trays must not be placed in the area surrounding the firing table, since this will obstruct the closing of the furnace head.

2.1.8



Contraindication

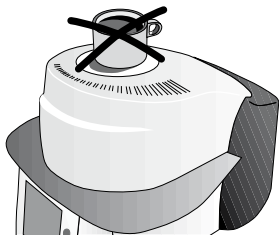

Foreign objects must not be placed on the furnace head or the air vents. Make sure that no liquids or other foreign objects enter the air vents, since this may result in an electrical shock.

2.1.9



Contraindication

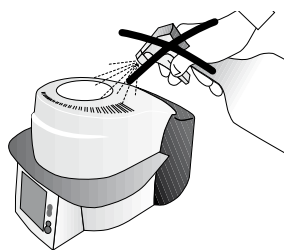

Make sure that no liquids or other foreign objects enter the furnace.

2.1.10



Contraindication

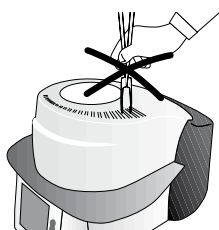

Do not insert any foreign objects into the air vents. There is a risk of electrical shock.

2.1.11



Risks of burn hazard

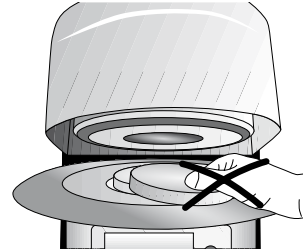

Never place objects in the firing chamber by hand, since there is a burn hazard. Always use the tongs (accessories) supplied for this purpose. Never touch the hot surface of the furnace head, as there is a burn hazard. Please also refer to the warnings on the furnace.

2.1.12



Risk of crushing and burn hazard

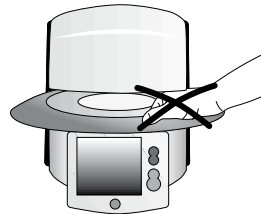

Never reach under the furnace head with the hand or other parts of the body during operation, since there is a risk of crushing and a burn hazard.

2.1.13



Risks and dangers

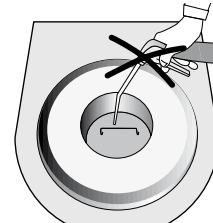

This product contains ceramic fibres and may release fibre dust. Do not use compressed air, or blow, on the furnace thus distributing the dust in the environment and observe the additional notes on page 11.

2.1.14



Risks and dangers

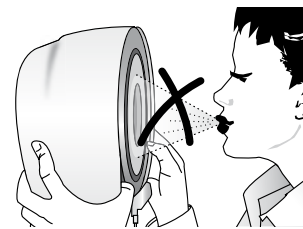

The furnace must not be operated if the quartz tube in the firing chamber is damaged. There is a risk of electric shock upon contact with the heating wire.

2.2 Health and Safety Instructions

This furnace has been designed according to EN 61010-1 and has been shipped from the manufacturer in excellent condition as far as safety regulations are concerned. To maintain this condition and to assure risk-free operation, the user must observe the notes and warnings contained in these Operating Instructions.

- The user must especially become familiar with the warnings and the operating conditions to prevent injury to personnel or damage to materials. The manufacturer is not responsible for damage resulting from misuse or failure to observe the Operating Instructions. Warranty claims cannot be accepted in such cases.
- Before switching on the furnace, make sure that the voltage indicated on the rating plate complies with your local power supply.
- The power socket must be equipped with a residual current circuit breaker.
- The furnace must be plugged into a socket with protected contacts.
- Place furnace on a fire-proof table (observe local regulations, e.g. distance to combustible substances or objects, etc.)
- Always keep the air vents at the rear and the side of the furnace free from obstruction.
- Do not touch any parts that become hot during the operation of the furnace. There is a burn hazard!
- Clean furnace only with a dry or slightly moist cloth. Do not use any solvents! Disconnect power before cleaning.
- The furnace must be cool before it is packed for transportation purposes.
- Use original packaging for transportation purposes.
- Before calibration, maintenance, repair, or exchange of parts, the power must be disconnected if the furnace is to be opened.
- If calibration, maintenance, or repair has to be carried out with the power connected and the furnace open, only qualified personnel, who are familiar with the risks and dangers, may perform these procedures.
- After maintenance, the required safety tests (high voltage resistance, protective conductor, etc.) have to be carried out.
- Ensure that only fuses of the indicated type and rated current are used.
- If it is assumed that safe operation is no longer possible, the power must be disconnected to avoid accidental operation. Safe operation is no longer possible if
 - the furnace is visibly damaged
 - the furnace does not work
 - the furnace has been stored under unfavourable conditions over an extended period of time
- Use only original spare parts.
- The temperature range for faultless operation is +5 °C to +40 °C (+41 °F to +104 °F).
- If the furnace has been stored at very low temperatures or high atmospheric humidity the head has to be opened and the unit dried or left to adjust to room temperature for approx. 1 hour (do not connect the power yet).
- The furnace has been tested for use at altitudes of up to 2000 m (6562 ft) above sea level.
- The furnace may only be used indoors.



Any disruption of the protective conductor either inside or outside the furnace or any loosening of the protective conductor connection may lead to danger for the user in case of malfunction. Deliberate interruptions are not tolerated.



Materials developing harmful gases must not be fired.

Warnings regarding the dismantling of the heating muffle



This product contains ceramic fibres and may release fibre dust. Fibre dust has proved to be carcinogenic in animal experiments. The corresponding EU Safety Data Sheet must be observed.

The heat insulation of the firing chamber in the Programat CS consists of ceramic fibres. After prolonged use of ceramic fibres at temperatures of over 900 °C (1652 °F), silicogenic substances (Cristobalite) may be produced. In certain cases, e.g. upon changing of the heating muffle, the possible resulting dust exposure may cause irritation of the skin, eyes, and respiratory organs. Therefore, proceed as follows when changing the heating muffle:

- Make sure the corresponding staff wears long-sleeved clothing, as well as headgear, goggles, and gloves.
- Place suction equipment at the source of the dust or, if not possible, provide the staff with FFP3 facemasks or similar items.
- Once the procedure has been completed, any dust possibly adhering to exposed skin must first be rinsed off with cold water. Only after that should soap and warm water be used.
- The corresponding work clothes should be washed separately.

Warning

The insulation on this product contains refractory ceramic fibres (RCF) which pose a possible cancer hazard, if agitated and inhaled. May be irritating to the skin, eyes or respiratory tract if insulation is cracked or corrupted.

California Proposition 65

Warning: "This product contains Refractory

Ceramic Fibres, a substance known to the State of California to cause cancer."

Disposal:



The furnaces must not be disposed of in the normal domestic waste. Please correctly dispose of old furnaces according to the corresponding EU council directive. Information on the correct disposal may also be found on your local Ivoclar Vivadent homepage.

3. Product Description

3.1 Components

The Programat CS comprises the following components:

- Furnace base with electronic controls
- Furnace head with firing chamber
- Firing table
- Cooling tray
- Power cord and hose for vacuum pump
- Vacuum pump (accessory)

3.2 Hazardous areas and safety equipment

Description of the risk areas of the furnace:

Hazardous area	Type of risk
Firing chamber	Risk of burning
Opening/closing mechanism	Risk of crushing
Electrical components	Risk of electrical shock

Description of the safety equipment of the furnace:

Safety equipment	Protective effect
Protective conductor	Protection from electrical shock
Electrical fuses	Protection from electrical shock

3.3 Functional description

The firing chamber may be heated up to max. 1200 °C (2192 °F) by means of a heating element. Furthermore, the firing chamber has been designed in such a way that a vacuum may be created with a vacuum pump. The firing process is controlled with the corresponding electronic controls and a software. Moreover, the set and actual temperatures are continuously compared.

3.4 Accessories (not part of the delivery form)

- Automatic Temperature Checking Set 2 (ATK 2)
- Programat Accessories Set (large and small firing trays, firing tongs, Temperature Checking Set)
- Vacuum pump

3.5 Indication/Contraindication

Indication

- Glaze and crystallization firings (chairside area)

Contraindication

- The Programat CS is not suitable as ceramic furnace for dental laboratories

4. Installation and Initial Start-Up

4.1 Unpacking and checking the contents

The packaging provides the following advantages:

- Reusable packaging
- Closing mechanism with integrated transportation grips
- Ideal protection by Styrofoam inserts
- Easy handling / optimum unpacking
- The packaging may be used in several ways (modules)

Remove the furnace components from their packaging and place it on a suitable table. Please observe the instructions on the outer packaging.

There are no special transportation grips on the furnace. Support the bottom of the furnace to carry it.

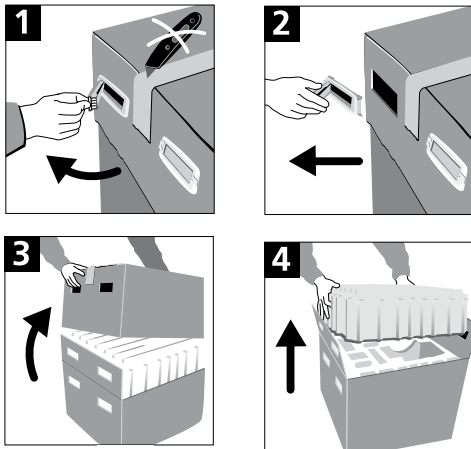

Check the delivery for completeness (see delivery form in Chapter 9) and transportation damage. If parts are damaged or missing, contact your local Ivoclar

Vivadent Service Center.

Packing and shipping of individual components:

The packaging of the Programat CS permits simple and safe shipping of individual components. Simply use the two corresponding inserts. Fold the side flaps (2) and combine the two packaging parts by means of the transportation flaps. The packaging may be disposed with the regular household refuse.

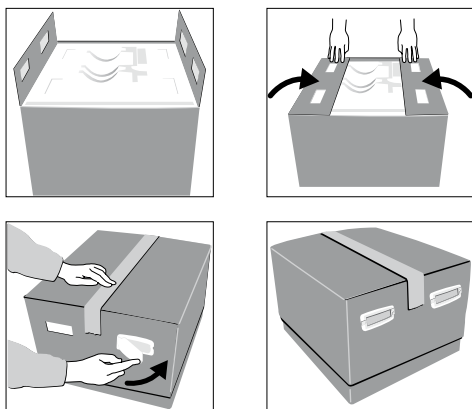

We recommend keeping the original packaging for future service and transportation purposes.

4.2 Selecting the location

Place the furnace on a flat table using the rubber feet. Make sure that the furnace is not placed in the immediate vicinity of heaters or other sources of heat. Make sure that air may properly circulate between the wall and the furnace.

Also ensure that there is enough space between the furnace and the user, as the furnace releases heat during the opening of the furnace head.

The furnace should neither be placed nor operated in areas where there is an explosion hazard.

4.3 Assembly

Make sure the voltage indicated on the rating plate (19) complies with the local power supply. If this is not the case, the furnace must not be connected.

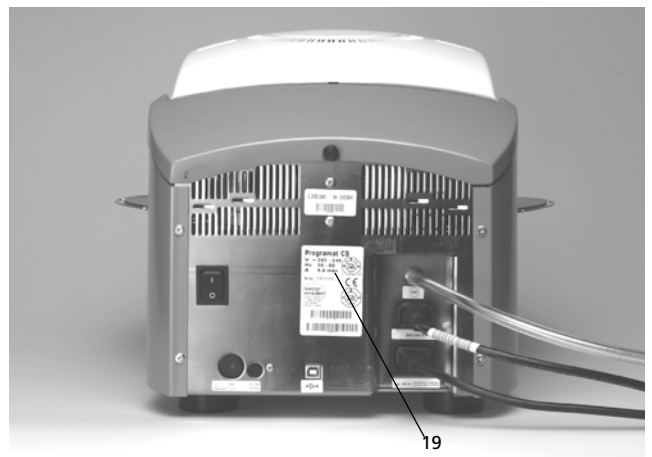

Step 1: Assembling the cooling tray (34)

Remove both screws (35) including the silicone washer (47) for the cooling tray (34).



Place the cooling tray (34) on the frame plate (7).
Make sure that the cooling tray (34) is correctly
positioned on the frame plate (7).



Secure the cooling tray (34) with the two screws
(35) including the silicone washer (47).



Step 2:
Placing the firing plate (5)
Place the firing plate (5) on the firing plate holder
(24).



Step 3:

Mounting the furnace head

The complete furnace head is best mounted with the rear panel of the furnace pointing towards the user. Lift the furnace head with both hands (see picture) and carefully position it on the furnace head mounting.



Ensure that the furnace head mounting mark (41) is aligned with the furnace base mounting mark (42).



Make sure that the firing plate (5) is not damaged by mounting the furnace head.



Step 4:

Connections

Connect the cables of the furnace head with the furnace base. Proceed as follows:

- Insert the thermocouple plug (26) (make sure that the polarity of the plug is correct)
- Insert the heater plug (28)



Secure the heater plug (28) with the plug fuse (27) by turning it until the heater plug (28) has been secured.



**Step 5:
Mounting the hood (36)**

Once all cables are properly connected to the furnace base, the hood (36) can be mounted.

Subsequently, secure the hood with the knurled screw (37).



The furnace may only be operated with the hood mounted.



**Step 6:
Establishing additional connections**

Power connection

Please make sure that the voltage indicated on the rating plate complies with the local power supply. Connect the power cord (16) with the power socket (17) of the furnace.

Vacuum pump connection

Connect the vacuum pump plug with the vacuum pump socket (18).

We recommend using only the VP3 easy or VP4 vacuum pumps from Ivoclar Vivadent, since these pumps are especially coordinated with the furnace. If other pumps are used, please observe and do not exceed the maximum power consumption.



4.4 Removing the furnace head

Before the hood (36) is removed, the furnace has to be switched off and the power cord (16) disconnected from the power socket (17).

1. Loosen and remove the knurled screw (37) of the hood (36)
2. Remove the hood (36)
3. Disconnect the thermocouple plug (26)
4. Disconnect the heater plug (28)
5. Press the leaf spring (32) with a finger, lift off the furnace head at the same time and remove it



Make sure the furnace head has completely cooled down before it is removed (fire hazard).

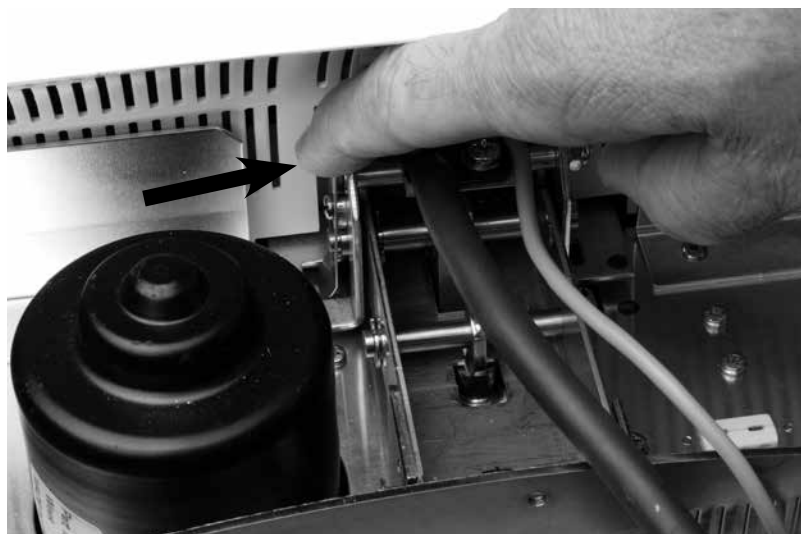

4.5 Initial start-up

1. Connect the power cord (16) with the wall socket.
2. Put the On/Off switch (11) at the rear of the furnace on position "I".

The furnace will now automatically conduct a self-test. The performance of all furnace components is automatically checked. The display shows the following indications during the self-test:



- 1 Status bar
- 2 Firing hours
- 3 SW version
- 4 Current supply voltage

If any component is defective, the corresponding error number (ER xxx) will be indicated in the display. If all components work properly, the display shows the stand-by mode.

Stand-by mode

The stand-by mode is indicated after the self-test. The furnace is set to the last used program.

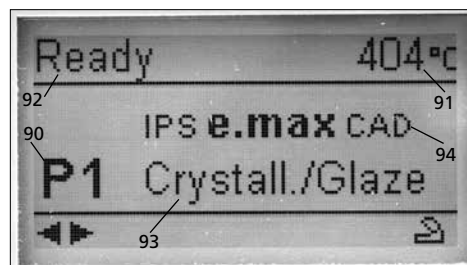

- 90 Program number
- 91 Current temperature
- 92 Status of furnace
- 93 Program name
- 94 Material name

5. Operation and configuration

5.1 Introduction to the operation

The Programat CS is equipped with a graphical display with back-lighting. By means of the enter keys and the command keys (B), the furnace may be programmed and controlled.

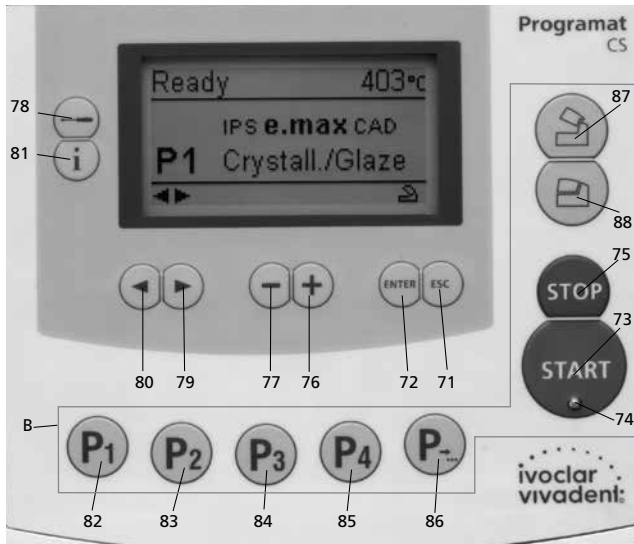

5.2 Explanation of key functions

- **Settings key (78)**
After pressing the 'Settings' key, the settings of the furnace can be displayed and/or changed one after the other.
- **Information key (81)**
After pressing the 'Information' key, the information about the furnace can be displayed one after the other.
- **Cursor keys (79, 80)**
By pressing the cursor keys in the stand-by mode, the program can be changed.
The cursor keys can be used to browse through the settings and/or information. In the list of parameters, the current cursor position is indicated by an illuminated (non-blinking) frame around the numerical value.
- **- / + keys (76, 77)**
Changing the settings or entry of a numerical value are carried out using the -/+ keys. Each individual entry by means of the -/' or '+ ' key is immediately accepted, provided the corresponding value range is observed. Once the limit of the value range is reached, the value is no longer adjusted.
- **ESC key (71)**
This key is used to close an error indication. Moreover, any screen can be left by pressing this key.
- **ENTER key (72)**
This key is used to select settings or confirm entries.
- **START key (73)**
Pressing this key starts the selected program. Starting a program is only possible with the furnace head open.
- **Start LED (74)**
Illuminated if a program has been started. The LED is blinking while a program is paused.
- **STOP key (75)**
Pressing this key once (program paused)
Pressing this key twice (program will be interrupted and vacuum flooded). With the STOP key the movement of furnace head and the beeper will be interrupted, too.

- **Open furnace head key (87)**
The furnace head is opened (not possible during a program in progress).
- **Close furnace head key (88)**
The furnace head is closed (not possible during a program in progress).
- **Program 1 key (82)**
Used to select Program 1 (P1) (not possible during a program in progress).
- **Program 2 key (83)**
Used to select Program 2 (P2) (not possible during a program in progress).
- **Program 3 key (84)**
Used to select Program 3 (P3) (not possible during a program in progress).
- **Program 4 key (85)**
Used to select Program 4 (P4) (not possible during a program in progress).
- **Next program key (86)**
Used to select the next program (P5, P6, ...) (not possible during a program in progress).

5.3 Basic meaning of the display information

- Stand-by mode

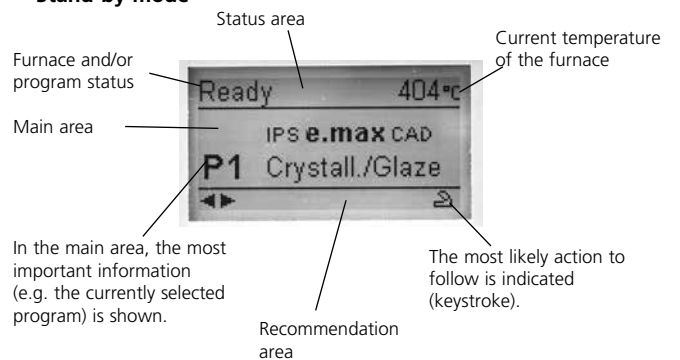

- Firing curve display

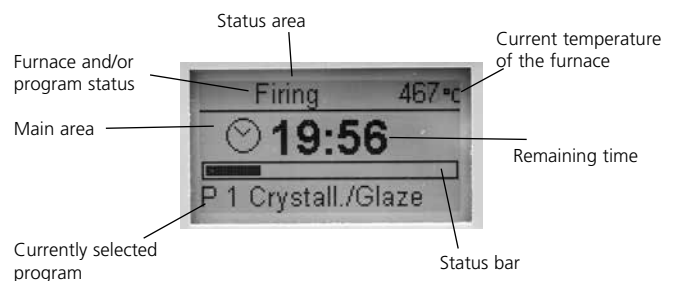

5.4 Program structure

The furnace offers three types of programs:

- Standard programs for Ivoclar Vivadent materials
- Free programs
- Test programs

a) Standard programs for Ivoclar Vivadent materials (see chapter 10.1)

- IPS e.max CAD
- IPS Empress CAD

b) Free programs

All free programs are available as equivalent and thus fully-fledged programs. All the parameters can be individually set for each program.



When the furnace is delivered ex works, the standard programs already contain the recommended material parameter settings.

However, the parameters can be changed and overwritten at any time, if required, if the programs are to be used for other purposes. Therefore, the 50 programs are also available as free programs.

The programs are designed in such a way that they can be either used as conventional, one-stage programs or as two-stage programs, if required. The mode can be changed via the symbol (one- or two-stage program) by using the + or – key.

c) Test programs

Various test programs are available. Please refer to chapter 5.5 Settings / configuration and information.

5.5 Adjustable parameters and possible value ranges

Symbol	Parameter	Value range	Value range
P	Program number P	1–20	
B	Stand-by temperature	100–700 °C	212–1292 °F
S	Closing time (min : sec)	00:18–30:00	
t [↑] (*)	Temperature increase rate	30–140 °C/min	54–252 °F/min
T	Holding temperature	100–1200 °C	212–2192 °F
H	Holding time (min : sec)	00.01–60:00	
V1	Vacuum on	0 or 1–1200 °C	0 or 34–2192 °F
V2	Vacuum off	0 or 1–1200 °C	0 or 34–2192 °F
t [↑] (*)	Temperature increase rate		
t2 [↑]	Second stage	30–140 °C/min	54–252 °F/min
T	Holding temperature		
	Second stage	100–1200 °C	212–2192 °F
H	Holding time		
	Second stage (min : sec)	00.01–60:00	
V1 (V1 2)	Vacuum on		
	Second stage	0 or 1–1200 °C	0 or 34–2192 °F
V2 (V2 2)	Vacuum off		
	Second stage	0 or 1–1200 °C	0 or 34–2192 °F
L	Long-term cooling	0 or 50–1200 °C	0 or 122–2192 °F
tL	Cooling temperature rate	0 or 1–50	0 or 32–90

(*) 100 V Version: 140°C/min (252°F/min)

Automatic plausibility check

The furnace is equipped with an automatic plausibility check function. The parameters (e.g. T 960 but L 1000) are checked upon each program start. In case of contradictory parameter combinations, the program stops automatically and the respective error number is indicated.

Examples of firings

– Typical glaze firing

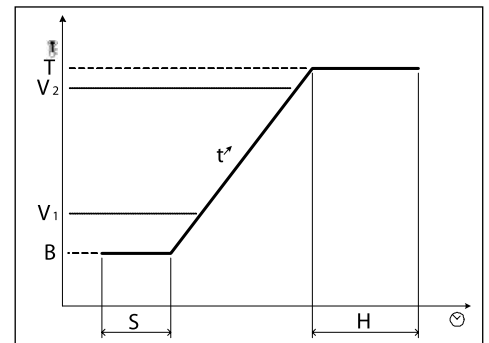

– Typical crystallization firing

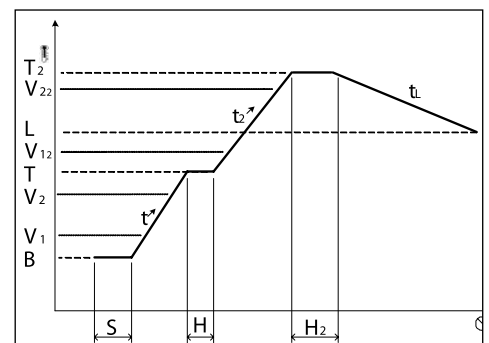



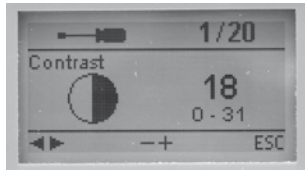

5.6 Settings / test programs





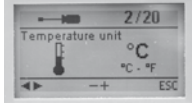
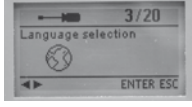
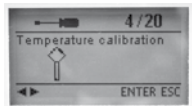

By pressing the „Settings“ key (78), the Settings will be displayed (indication of the last selected Settings).



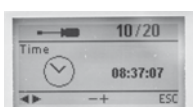
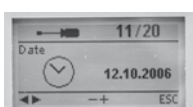

The cursor keys (79, 80) are used to toggle between the possible settings. This screen can be exited with the ESC key (71) or a Program key (82, 83, ...).

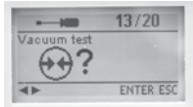
5.6.1 Settings / Configuration

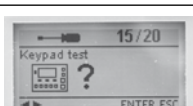
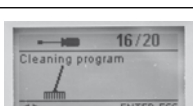
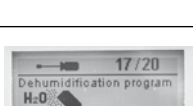
Settings	Display	Short description
Contrast		The contrast can be set by means of the + or – keys
Temperature mode		The + and – keys can be used to switch from °C to °F
Language selection		Enables language selection
User calibration value		This program is suitable to conduct the temperature calibration by means of the ATK 2. The furnace head opens automatically if the Enter key is pressed. Now insert the ATK 2 sample in the intended hole (see 7.6 Temperature calibration) and start the program by means of the START key.
Volume		The desired volume can be set by means of the + or – keys
Beeper tune		The tune can be set by means of the + or – keys
Programming		Enables the programming of the parameters of the currently selected program. *

Settings	Display	Short description
Renaming		Enables the renaming of the currently selected program. *
		Enables the renaming of the materials.
Time		The time can be entered by using the – / + keys
Date		The date can be selected by using the – / + keys
General write protection		Enables activation or deactivation of the general write protection by means of the ,-/+' keys once the user code has been entered.
Vacuum test program		Allows to check the vacuum quality of the system
Heating muffle test program		Allows to check the heating muffle. The result is shown in graphical form after the end of the program
Key test		Allows to check the keypad
Cleaning program		The program is used to clean the heating muffle and the insulation materials by a heat process.
Dehumidification program		Permits the dehumidification of the furnace

* Some programs are protected with a code. If there will be necessary changes, you will be informed about the corresponding code.

Settings	Display	Short description
"Ivoclar Vivadent optimized temperature control function"		Only after entry of the STD code. Enables the deactivation of the "Ivoclar Vivadent optimized temperature control function"
Selection of factory settings		With this setting, all values and parameters can be reset to the factory settings. Attention: All individual programs which have been created and saved will be deleted with this function.







Important information

The user code (6725) is required for some settings.

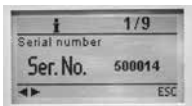



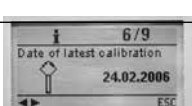
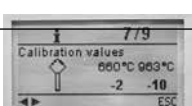
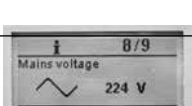
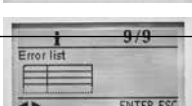

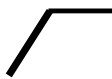

5.5.2 Information

By pressing the 'Information' key (81), you can access the information display (the latest information selected is being displayed). You can browse through the various information using the cursor keys (79, 80). You can exit this display by hitting ESC (71) or one of the program keys (82, 83, ...).

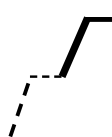
Settings	Display	Short description
Serial number		Serial number of the furnace
Software version		
Furnace head firing hours		
Operating hours furnace		
Operating hours vacuum pump		
Latest start of calibration program		
Calibration value		Calibration value 660°C and 963°C
Supply voltage		Shows the current supply voltage
Error list		Enables the display of the latest error messages.

Short description

5.7 Symbols in the display

Symbol name	Meaning	Symbol
"One-stage program"	Indicates that a conventional, one-stage program is used	
"Two-stage program"	Indicates that a specific, two-stage program is used. The bold line indicates the values for the first stage	
"Two-stage program"	Indicates that a specific, two-stage program is used. The bold line indicates the values for the second stage	
Furnace head open	Is shown in the recommendation area and indicates the most likely action to follow.	
Furnace head close	Is shown in the recommendation area and indicates the most likely action to follow.	
Press START	Is shown in the recommendation area and indicates the most likely action to follow.	START
Press STOP	Is shown in the recommendation area and indicates a possible action.	STOP
Press ENTER	Is shown in the recommendation area and indicates a possible action.	ENTER
Press ESC	Is shown in the recommendation area and indicates a possible action.	ESC
Using cursor keys	Is shown in the recommendation area and indicates a possible action.	
Using - / + keys	Is shown in the recommendation area and indicates a possible action.	- +
General write protection	Indicates in the parameter list that the general write protection has been activated by means of the user code.	
Individual write protection activated	Indicates in the parameter list that the individual write protection has been activated for this program	
Individual write protection not activated	Indicates in the parameter list that this program is not write-protected	

5.8 Explanation of beeper tunes

Beeper description	Explanation
Beeper lasting for approx. 2 seconds with unchangeable "Self-test signal" to indicate the completion of the self-test.	Self-test has been completed
Beeper lasting for approx. 5 seconds with the beeper signal set by the user.	The firing process has been completed and the furnace head is open *.
Beeper with unchangeable "error tune".	Error messages are supported by the error tune *
A short beeper signal will sound every time a key is pressed (approx. 0.5 seconds ON) basically at the volume set by the user. If the volume is set to OFF, then the signal sounds at a medium volume.	Keypad test active

* The beeper can be interrupted by means of the STOP key.

6. Practical Use

The operating procedure for the Programat CS will be explained with the help of two examples: one standard and one individual program.

6.1 Switching on/off

Put ON/OFF switch (11) on position "I". The furnace conducts an automatic self-test, which will be indicated in the beginning. Subsequently, a status bar shows that the self-test is being conducted. Make sure that the furnace is not manipulated during this time.

6.1.1 Stand-by mode

After successful completion of the self-test, the Stand-by mode is shown in the display.

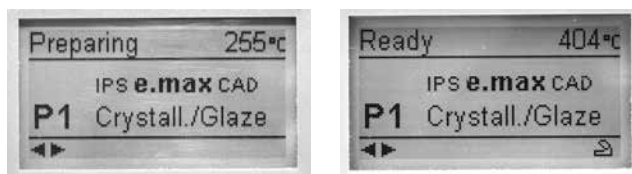

While the furnace heats up to the stand-by temperature the status is shown in „Preparing“.

As soon as the stand-by temperature has been reached, the status indication changes to „Ready“. Furthermore, the ‚open furnace head‘ symbol is shown in the recommendation area, thus indicating the most likely action to follow.

After the furnace head has been opened and the object placed, the program may be started by pressing the START key. For that purpose, the START symbol is indicated in the recommendation area. The program can only be started if the furnace head is open.



6.1.2 Description of the firing curve display

If the program is started with the START key, the firing curve display is shown.



The following information is always displayed:

- a) Status of program
- b) Remaining time
- c) Current temperature
- d) Program number
- e) Program name
- f) Status bar

6.2 Firing using a standard program

Step 1:

Select with the program keys the desired program (1 to 50) according to the firing table.

Step 2:

Open the furnace head with the "Open furnace head" key (87) and place the object on the firing tray in the furnace.

Step 3:

Press the START key (73). The program can only be started with the furnace head open. The process is indicated in the firing curve display.

6.3 Firing using an individual program

Step 1:

Select a free program.

Step 2:

Select the parameter list via the setting ‚Programming‘ (7/20) and change the program parameters using the ‚-/+‘ keys. After that, change back to the Stand-by screen by pressing ESC or the Program key.



Step 3:

Now, open the furnace head using the ‚Open furnace head‘ key (87) and position the firing tray with the object in the furnace. Press the START key (73) and the program is started. The program can only be started if the furnace head is open. The sequence can be observed on the firing curve screen.



6.4 Further possibilities and special features of the furnace

6.4.1 General write protection

If all programs are write-protected, a closed, black lock appears. The setting ‚Renaming‘ cannot be selected if the general write protection is activated. As an indication, a closed lock is shown next to the keyboard symbol.

6.4.2 Stopping the running program

Press the STOP key once to pause a running program. The green LED in the START key blinks. Furthermore, the status indicated is ‚Pause‘. Press the STOP key twice to completely stop the program or press START to continue.

6.4.3 Individual program write protection

For the standard programs, the individual program write protection is activated as part of the factory settings. In this way, accidental change of the parameters is prevented. The individual program write protection (symbol) can be changed for each program individually via the setting ‚Programming‘ (7/20) using the ‚-/+‘ keys.

6.4.4 Renaming

The keyboard can be selected via the setting ‚Renaming‘ (8/20, 9/20), provided that the currently selected program is not write-protected. The desired letters can be selected using the cursor keys (circulating). The letter is selected with the ENTER key. Individual letters can be deleted using the ‚delete‘ key (arrow symbol). The changes are saved using the ‚save‘ key (disk symbol) or the ESC key. With this action, the keyboard display is also exited.

This key enables the shift to lower case letters, numbers/



symbols and back to upper case letters.

6.5 Programming

One-stage program *

The parameter list can be selected via the setting 'Programming' (7/19). In this list, all the program parameters are shown. The desired parameter can be selected using the cursor keys. The value can be changed using the ',-/+' keys. This screen can be exited with the ESC or the Program keys.

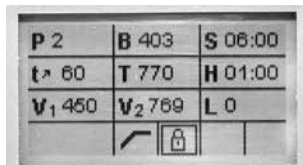

If the cursor is on the symbol 'one-stage', pressing the ',-/+' keys allows to switch from a one-stage program to a two-stage program.

Two-stage program

If a two-stage program is used, the parameters are displayed for the first and the second stage in a separate screen. Switching between the two screens is carried out using the symbol 'Change program stage indication'.

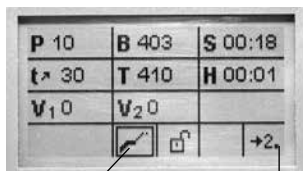

stage 1 is shown

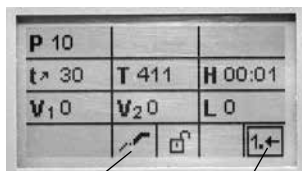

stage 2 is shown

Symbol 'Change program stage indication'

If the cursor is on the symbol 'Change program stage indication', pressing the 'ENTER' key results in a change of the program stage indication.

If the cursor is on the symbol 'one-stage/two-stage', pressing the ',-/+' keys allows to switch from a two-stage program to a one-stage program.

* The programs are protected with a code. If there will be necessary changes, you will be informed about the corresponding code.

7. Maintenance, Cleaning, and Diagnosis

This chapter describes the user maintenance and cleaning procedures for the Programat CS. All the other tasks must be performed by qualified service personnel at a certified Ivoclar Vivadent Service Center.



This furnace has been developed for typical use in dental laboratories. If the product is used in a production enterprise, for industrial applications, and for continuous use, premature ageing of the expendable parts has to be expected.

7.1 Monitoring and maintenance

The time for these maintenance procedures depends on the frequency of use and the working habits of the users. For that reason, the recommended times are only approximations.

The expendable parts are as follows:

- Heating muffle
- Insulation material

Expendable parts are not covered by the warranty. Please also observe the shorter service and maintenance intervals.

What	Part	When
Check all plug-in connections for correct fit	Var. external connections	weekly
Check if the furnace head opens smoothly and without excessive noise.	Opening mechanism	monthly
Check if the thermocouple is straight and in the right place.	Thermocouple (4)	weekly
Check the insulation for cracks and damages. If the insulation is worn down it has to be replaced by a certified Ivoclar Vivadent Service Center. Fine hair-line cracks on the surface of the insulation are harmless and do not influence the function of the furnace in a negative fashion.	Insulation (3)	monthly
Check if the sealing rims of the furnace head and the furnace base are clean and undamaged.	Sealing rims of the furnace head (2) and the furnace base (1)	weekly
Check the keypad for visible damage. If the keypad is damaged, it has to be replaced by a certified Ivoclar Vivadent Service Center.	Keypad (10)	weekly
Check temperature. Use the temperature checking set to check and adjust the temperature in the furnace.	Firing chamber	twice a year
Check the quartz glass cylinder to make sure the quartz glass is not defective.	Firing chamber	daily



If the furnace head is replaced, the furnace must be calibrated.

7.2 Cleaning



The furnace may only be cleaned when it is cool, since there is a burn hazard. Do not use any cleaning solutions.

The following parts have to be cleaned from time to time:

Item:	Frequency:	Cleaning material:
Housing (9) and furnace head (25)	if required	soft, dry cloth
Keypad (10)	weekly	soft, dry cloth
Cooling tray (34)	daily	cleaning brush *
Insulation (3)	daily	cleaning brush *
Sealing rim of the furnace head (2) and sealing surface (1)	daily	cleaning brush and a soft cloth *

*Never clean with compressed air!

7.3 Test programs

Press the the key 'Settings' and select the desired test program by using the Cursor-keys.

Vacuum pump test program:

With this program, the vacuum performance of the furnace vacuum system can be automatically tested. For that purpose, the achieved (minimum) pressure in mbar is measured and indicated. If the pressure value is below 80 mbar, the vacuum performance of the system is adequate.

Heating muffle test program

With this heater test, the quality of the heating muffle can be automatically tested (duration approximately 7 minutes). The heating muffle test should only be conducted with the firing chamber empty, since any additional item in the firing chamber (e.g. firing tray) influences the result. Please run the heating muffle test program immediately after switching on the furnace and before starting the actual firing procedures. If the furnace is too hot, an incorrect heating muffle quality will be indicated. If the quality of the heating elements drops below 50%, changing the heating element is strongly recommended.

Keypad test program

With every keystroke a short beep sounds. The keypad test is ended by pressing the ESC key.

Cleaning program

The heating muffle is ,cleaned' using the cleaning program (duration approximately 17 minutes).

7.4 Stand-by

We recommend keeping the furnace head closed, especially if the temperature drops below 150 °C (302 °F).

7.5 Dehumidification program

The condensation of water in the insulation of the firing chamber and the vacuum pump will result in a lower vacuum and thus impaired firing results. For that reason, the furnace head should be kept closed when the furnace is switched off, in order to prevent the absorption of humidity. Start the dehumidification program if required (humidity in the insulation).

7.6 Temperature calibration

1. Select the calibration program.

2. Remove the firing plate from the furnace using the furnace tongs and place it on the cooling tray.

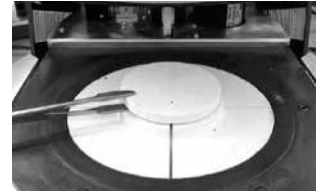

3. Carefully grip the upper part of the ATK 2 using the furnace tongs (Caution: Fracture risk of the ceramic) and insert it into the holes designated for this purpose until it snaps into place. The orientation of the calibration sample (left or right) is not important.

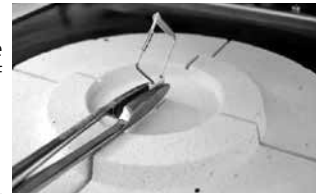

4. If necessary, use the furnace tongs to apply slight pressure to the center of the calibration base until the calibration sample clicks into place. Observe the corresponding markings.

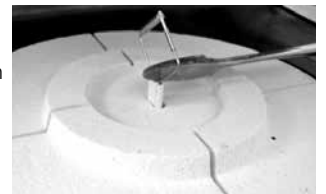

5. Start the calibration program

6. At the end of the program, open the furnace head and carefully remove the ATK 2 using the furnace tongs and place it on the cooling tray to allow it to cool.

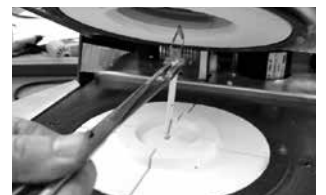

7. Replace the firing plate using the furnace tongs.

8. Close the furnace head and select a firing program.

9. The ATK 2 can only be used once. Use a new calibration set for the next calibration procedure.

8. What if ...

This chapter will help you to recognize malfunctions and take appropriate measures or, if possible and acceptable, to perform some simple repairs.

8.1 Error messages

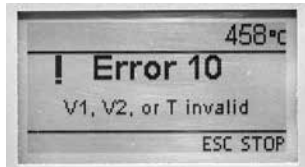

The furnace continuously checks all functions during operation. If an error is detected, the respective error message is displayed.

In case of an error, the heater switches off for safety reasons.

The following error messages may be displayed:

Index	Category	Error	ERR No.	Continuation possible	Error Message Text
1	Entry	T < B	2		Enter a logical value for T
2	Entry	L > T	8		Enter a logical value for long-term cooling L
3	Entry	V2x <= V1x	9		Enter a logical value for the vacuum-on temperature Vx1 or the vacuum-off temperature Vx2
4	Entry	V2x > Tx + 1°C	10		Change either the vacuum values or the holding time T
5	Entry	Incorrect values for V1x, V2x	11		Enter a logical value for V1x, V2x
6	System	Current temperature after Start > Tx + 50 °C	13 *, **		Excess temperature! Program aborted, furnace head opens to allow the furnace to cool down.
8	Entry	T2 < T1	16		Enter a lower value for T1 or a higher value for T2.
9	System	Power failure > 10 s during a firing program in progress	17		A firing program in progress was interrupted for more than 10 s. The program cannot be continued!
10	Entry	T1 > V12	18		Enter a lower value for T1 or a higher value for V12
11	Entry	VV set, but V2 is missing or invalid	19		Pre-vacuum activated! V2 must be higher than B.
12	System	Error in the heating system	20 **	no	Check the heater fuse. If the fuse is O.K., contact your local Ivoclar Vivadent Service Center.
13	System	Heating muffle very old	23		The heating muffle is very old. It is recommended to replace it. After the error message has been acknowledged, a firing program may still be started.
14	System	Heating muffle defective	24		The condition of the muffle is so poor that it has to be replaced immediately.
16	Entry	T is > B + 200 °C at the start of a firing program	26		Firing chamber too hot to start a firing program.
17	System	Furnace head cannot be initialized	27 **, ***		The furnace head cannot be moved to the final position. It might be blocked by an external mechanical source! If this is not the case, please contact your local Ivoclar Vivadent Service Center!
18	System	The furnace head does not reach the target position	28 **		The furnace head does not open/close correctly. The furnace head was manually moved or is obstructed. The furnace head must only be moved using the keys intended for this purpose!
21	System	Necessary vacuum (xxxmbar) is not reached within 1 min.	33		The vacuum cannot be established. Check the seal of the firing chamber, vacuum hose, vacuum pump, pump fuse.
33	Entry	HV > H (H2)	110		Enter a lower value for HV or a higher value for H (H2)
35	Entry	„Share of the holding time with vacuum“ is activated, but Vx2 does not correspond to Tx or Tx+1	120		Activate the vacuum during the holding time Tx or deactivate HV.
38	System	Brief power failure during a firing program in progress	702		A firing program in progress was interrupted by a brief power failure. The program is continued!
45	System	Vacuum drop	801		An unacceptable vacuum drop has occurred.
46	System	The vacuum does not increase (self-test)	802		No vacuum increase could be measured. Check the following points: Is the firing chamber tight (no contamination on the sealing surfaces)? Is the vacuum hose connected? Is the vacuum pump connected? Is the fuse F1 o.k.?
75	System	ATK2 calibration: Pre-heating to 963 °C	1302 **		Error during calibration. Sample may not be correctly inserted. Try again with a new sample and make sure the sample makes ample contact.
79	Note	Calibration reminder	1310		Some time has passed since the last calibration procedure. Calibrate the furnace soon.
80	Note	Dehumidification reminder	1312		Some time has passed since the last dehumidification procedure. Dehumidify the furnace soon.

Behaviour of the furnace in case of error

* Furnace head opens when this error occurs.

** A program in progress is stopped.

*** The error cannot be acknowledged; the programs cannot be started.

8.2 Other error messages

Please contact the Ivoclar Vivadent After Sales Service, if one of the following error messages being displayed:

25, 29

32

43, 44, 45, 46, 47, 48

54, 56

103, 107

700, 701, 703, 704, 705, 706, 707

800

1010, 1011, 1012, 1013, 1014, 1015, 1016

1024, 1025, 1026, 1028

1202, 1203, 1204, 1205, 1206, 1207

1300, 1301, 1303, 1304, 1305

1400, 1401, 1402

1500

8.3 Technical malfunctions

These malfunctions may occur without an error message being displayed.

* If there are any questions, please contact the Ivoclar Vivadent After Sales Service.

Description	Double-check	Action
Vacuum is not released or only very slowly	Is the vacuum released within approximately 30 seconds?	Wait until the vacuum is released, remove object. Switch the furnace on and off again *
Indication on display incomplete	Activate the display test program	*
Writing in the display is very hard to read	Is the contrast properly set?	Adjust contrast
Display not illuminated	Is the furnace properly connected according to the Operating Instructions and switched on?	Correctly connect the furnace and switch it on.
Buzzer does not sound	Is the buzzer switched off (Tune 0)?	Select tune 1–5
Furnace head does not open	Was the furnace head moved manually?	Open the furnace head only by using the corresponding keys. Switch the furnace on and off again
	Has the vacuum already been released?	Is the program still running? Wait until the program is complete. Switch furnace off and on again *
Vacuum pump does not start working	Is the vacuum pump fuse defective?	Check fuse and replace if necessary.
	Was the maximum power consumption exceeded?	Use only the vacuum pump recommended by Ivoclar Vivadent.
	Is the vacuum pump plug correctly connected?	Correctly connect the vacuum pump to the furnace base.
Final vacuum is not reached	Is the vacuum hose OK?	Check vacuum hose and hose connection.
	Is the pump output OK?	Start the vacuum test program.
	Humidity/condensation in the vacuum hose?	Start dehumidification program.
Incorrect or illogical temperature indication	Is the thermocouple bent or fractured?	*
	Is the thermocouple correctly connected?	Correctly connect thermocouple.
	Is the thermocouple plug defective?	*
Hairline cracks in the heating muffle	Are the cracks very small and insignificant (hairline cracks)?	Small cracks in the muffle are normal and do not negatively influence the function of the furnace.
	Are the cracks large or have parts of the heating muffle broken off?	*
Cracks in the insulation	Are the cracks very small and insignificant (hairline cracks)?	Small cracks in the insulation do not negatively influence the furnace.
	Are the cracks large or have parts of the insulation broken off?	*
Cracks in the quartz glass / heating element	Are there cracks in the quartz glass or is the quartz glass sheathing the heating wire broken?	Switch off the furnace *

8.4 Repair



Repairs may only be carried out by a certified Ivoclar Vivadent Service Center. Please refer to the addresses on the last page of these Operating Instructions.

If repairs during the warranty period are not carried out by a certified Ivoclar Vivadent Service Center, the warranty will expire immediately. Please also refer to the corresponding warranty regulations.

9. Product Specifications

9.1 Delivery form

- Programat CS
- Power cord
- Vacuum hose
- Cooling Tray "S"
- Programat Firing tongs
- Programat Firing Tray Kit
- Automatic Temperature Calibration Set ATK2 (Test Set)
- USB data cable
- PrograBase 2 Software
- Service passport equipment
- Operating Instructions

Recommended accessories

- Programat Accessories Set
- Automatic Temperature Checking Set 2 (ATK 2)
- Vacuum Pump VP3 easy

9.2 Technical data

Power supply	100 V / 50–60 Hz 110–120 V / 50–60 Hz 200–240 V / 50–60 Hz
Overvoltage category II	
Contamination level 2	
Tolerated voltage fluctuations	+/- 10%
Max. power consumption	11 A at 100 V 12 A at 110–120 V 8.5 A at 200–240 V
Acceptable data for vacuum pump of other manufacturers	
Max. output:	250 W / max. leakage current 0.75 mA
Final vacuum:	< 50 mbar Use only tested pumps
Electrical fuses:	100 V / 110–120 V: 250 V / T 15 A (heating circuit) 250 V / T 5 A (vacuum pump) 200–240 V: 250 V / T 8 A (heating circuit) 250 V / T 3.15 A (vacuum pump)
Dimensions of electrical fuses	110–120 V: Diameter 6.3 x 32 mm 200–240 V: Diameter 5 x 20 mm
Dimensions of the closed furnace	Depth: 430 mm / width: 305 mm / 410 mm (with Cooling tray) Height: 320 mm
Usable size of the firing chamber	Diameter 80 mm Height 48 mm
Max. firing temperature	1200 °C (2192 °F)
Weight	Furnace base: 12.0 kg Furnace head: 4.5 kg

Safety information

The CS complies with the following guidelines:

- IEC 1010-1/EN 61010, Part 1
- UL and cUL standards

Radio protection / electromagnetic compatibility EMC tested

9.3 Acceptable operating conditions

Acceptable ambient temperature range:
+5 °C to +40 °C (+41 °F to +104 °F)

Acceptable humidity range:
80 % maximum relative humidity for temperatures up to 31 °C (87.8 °F) gradually decreasing to 50 % relative humidity at 40 °C (104 °F); condensation excluded.

Acceptable ambient pressure:
The furnace is tested for use at altitudes of up to 2000 m above sea level.

9.4 Acceptable transportation and storage conditions

Acceptable temperature range	-20 to +65 °C (-4 °F to +149 °F)
Acceptable humidity range	Max. 80 % relative humidity
Acceptable ambient pressure	500 mbar to 1060 mbar

Use only original packaging of the Programat CS together with the respective foam material for shipping purposes.

10. Appendix

10.1 Program table

The program tables (°C / °F) are enclosed in the Operating Instructions. Should this not be the case, please contact the Ivoclar Vivadent Service Center.



Important Information

You also will find the program tables in the Internet:
www.ivoclarvivadent.com/downloadcenter

You can download the program tables as PDF files from this side. Please note, that the version of the program tables should correspond to the Software version which is used on your furnace.

10.2 Program structure

Program	Description
1	Crystallization/glaze program for IPS e.max CAD HT/LT
2	Corrective firing for IPS e.max CAD
3	Speed Crystallization/glaze program for IPS e.max CAD HT/LT
4	Stain and glaze program for IPS Empress CAD
5	Fusion/Crystallization program for the IPS e.max CAD-on technique
6	Characterization/glaze program for the IPS e.max CAD-on technique
7	Crystallization program for IPS e.max CAD Impulse
8 to 20	Individual Programs

Please observe the notes in the Instructions for Use of the corresponding material.

Ivoclar Vivadent – worldwide

Ivoclar Vivadent AG

Bendererstrasse 2
FL-9494 Schaan
Liechtenstein
Tel. +423 235 35 35
Fax +423 235 33 60
www.ivoclarvivadent.com

Ivoclar Vivadent Pty. Ltd.

1 – 5 Overseas Drive
P.O. Box 367
Noble Park, Vic. 3174
Australia
Tel. +61 3 979 595 99
Fax +61 3 979 596 45
www.ivoclarvivadent.com.au

Ivoclar Vivadent Ltda.

Alameda Caiapós, 723
Centro Empresarial Tamboaré
CEP 06460-110 Barueri – SP
Brazil
Tel. +55 11 2424 7400
Fax +55 11 3466 0840
www.ivoclarvivadent.com.br

Ivoclar Vivadent Inc.

1-6600 Dixie Road
Mississauga, Ontario
L5T 2Y2
Canada
Tel. +1 905 670 8499
Fax +1 905 670 3102
www.ivoclarvivadent.us

Ivoclar Vivadent Shanghai) Trading Co., Ltd.

2/F Building 1, 881 Wuding Road,
Jing An District
200040 Shanghai
China
Tel. +86 21 6032 1657
Fax +86 21 6176 0968
www.ivoclarvivadent.com

Ivoclar Vivadent Marketing Ltd.

Calle 134 No. 7-B-83, Of. 520
Bogotá
Colombia
Tel. +57 1 627 33 99
Fax +57 1 633 16 63
www.ivoclarvivadent.co

Ivoclar Vivadent SAS

B.P. 118
F-74410 Saint-Jorioz
France
Tel. +33 450 88 64 00
Fax +33 450 68 91 52
www.ivoclarvivadent.fr

Ivoclar Vivadent GmbH

Dr. Adolf-Schneider-Str. 2
D-73479 Ellwangen, Jagst
Germany
Tel. +49 (0) 79 61 / 8 89-0
Fax +49 (0) 79 61 / 63 26
www.ivoclarvivadent.de

Ivoclar Vivadent Marketing (India) Pvt. Ltd.

503/504 Raheja Plaza
15 B Shah Industrial Estate
Veera Desai Road, Andheri (West)
Mumbai, 400 053
India
Tel. +91 (22) 2673 0302
Fax +91 (22) 2673 0301
www.ivoclarvivadent.in

Ivoclar Vivadent s.r.l.

Via Isonzo 67/69
40033 Casalecchio di Reno (BO)
Italy
Tel. +39 051 611 35 55
Fax +39 051 611 35 65
www.ivoclarvivadent.it

Ivoclar Vivadent K.K.

1-28-24-4F Hongo
Bunkyo-ku
Tokyo 113-0033
Japan
Tel. +81 3 6903 3535
Fax +81 3 5844 3657
www.ivoclarvivadent.jp

Ivoclar Vivadent Ltd.

12F W-Tower, 1303-37
Seocho-dong, Seocho-gu,
Seoul 137-855
Republic of Korea
Tel. +82 (2) 536 0714
Fax +82 (2) 596 0155
www.ivoclarvivadent.co.kr

Ivoclar Vivadent S.A. de C.V.

Av. Insurgentes Sur No. 863,
Piso 14, Col. Napoles
03810 México, D.F.
México
Tel. +52 (55) 50 62 10 00
Fax +52 (55) 50 62 10 29
www.ivoclarvivadent.com.mx

Ivoclar Vivadent Ltd.

12 Omega St, Rosedale
PO Box 303011 North Harbour
Auckland 0751
New Zealand
Tel. +64 9 914 99 99
Fax +64 9 914 99 90
www.ivoclarvivadent.co.nz

Ivoclar Vivadent Polska Sp. z o.o.

Al. Jana Pawla II 78
00-175 Warszawa
Poland
Tel. +48 22 635 54 96
Fax +48 22 635 54 69
www.ivoclarvivadent.pl

Ivoclar Vivadent Marketing Ltd.

Prospekt Andropova 18 korp. 6/
office 10-06
115432 Moscow
Russia
Tel. +7 499 418-03-00
Fax +7 499 418-03-10
www.ivoclarvivadent.ru

Ivoclar Vivadent Marketing Ltd.

Qlaya Main St.
Siricon Building No.14, 2nd Floor
Office No. 204
P.O. Box 300146
Riyadh 11372
Saudi Arabia
Tel. +966 1 293 83 45
Fax +966 1 293 83 44
www.ivoclarvivadent.com

Ivoclar Vivadent Pte. Ltd.

171 Chin Swee Road
#02-01 San Centre
Singapore 169877
Tel. +65 6535 6775
Fax +65 6535 4991
www.ivoclarvivadent.com

Ivoclar Vivadent S.L.U.

c/ Emilio Muñoz N° 15
Entrada c/ Albarracin
E-28037 Madrid
Spain
Tel. + 34 91 375 78 20
Fax + 34 91 375 78 38
www.ivoclarvivadent.es

Ivoclar Vivadent AB

Dalvägen 14
S-169 56 Solna
Sweden
Tel. +46 (0) 8 514 93 930
Fax +46 (0) 8 514 93 940
www.ivoclarvivadent.se

Ivoclar Vivadent Liaison Office

: Tesvikkiye Mahallesi
Sakayik Sokak
Nisantas' Plaza No:38/2
Kat:5 Daire:24
34021 Sisli – Istanbul
Turkey
Tel. +90 212 343 08 02
Fax +90 212 343 08 42
www.ivoclarvivadent.com

Ivoclar Vivadent Limited

Ground Floor Compass Building
Feldspar Close
Warrens Business Park
Enderby
Leicester LE19 4SE
United Kingdom
Tel. +44 116 284 78 80
Fax +44 116 284 78 81
www.ivoclarvivadent.co.uk

Ivoclar Vivadent, Inc.

175 Pineview Drive
Amherst, N.Y. 14228
USA
Tel. +1 800 533 6825
Fax +1 716 691 2285
www.ivoclarvivadent.us

Version: 4

Date information prepared: 08/2012

Valid as of Software V3.0

This apparatus has been developed solely for use in dentistry. Start-up and operation should be carried out strictly according to the Operating Instructions. Liability cannot be accepted for damages resulting from misuse or failure to observe the Instructions. The user is solely responsible for testing the apparatus for its suitability for any purpose not explicitly stated in the Instructions. Descriptions and data constitute no warranty of attributes.

Printed in Austria
© Ivoclar Vivadent AG, Schaan/Liechtenstein
604261/03.09.2011/e

ivoclar
vivadent®