

Programat® S1



Operating Instructions

Valid as of
Software Version 3.0

CE

ivoclar
vivadent®
technical

Table of Contents

Views of the Furnace, List of Parts	4
1. Introduction / Signs and Symbols	8
1.1 Preface	
1.2 Signs and symbols	
1.3 Notes regarding the Operating Instructions	
1.4 Notes regarding the different voltage versions	
2. Safety First	9
2.1 Indications	
2.2 Health and safety instructions	
3. Product Description	12
3.1 Components	
3.2 Hazardous areas and safety equipment	
3.3 Description of functions	
3.4 Accessories	
3.5 Indications / contraindications	
4. Installation and Initial Start-Up	13
4.1 Unpacking and checking the contents	
4.2 Selecting the location	
4.3 Assembly	
4.4 Demounting the furnace head	
4.5 Initial start-up	
5. Operation and Configuration	18
5.1 Introduction to the operation	
5.2 Explanation of the key functions	
5.3 Basic meaning of the display readouts	
5.4 Program structure	
5.5 Settable parameters and possible value ranges	
5.6 Settings / test program and information	
5.7 Explanation of the display symbols	
5.8 Explanation of the acoustic signals	
5.9 OSD	
6. Practical Use	23
6.1 Switching on the furnace	
6.2 Loading the Programat S1	
6.3 Sintering procedure with a standard program	
6.4 Sintering procedure with an individual program	
6.5 Additional possibilities and special features of the furnace	
6.6 Programming	
7. Maintenance, Cleaning and Diagnosis	25
7.1 Cleaning of the sintering chamber and the heating elements	
7.2 Monitoring and maintenance	
7.3 Cleaning	
7.4 Test programs	
7.5 Stand-by	
7.6 Temperature calibration	
7.7 Service hint	
8. What If...	27
8.1 Error messages	
8.2 Technical malfunctions	
8.3 Repair	
9. Product Specifications	30
9.1 Delivery form	
9.2 Technical data	
9.3 Acceptable operating conditions	
9.4 Acceptable transportation and storage conditions	
10. Miscellaneous	31
10.1 Program table	

List of Parts

- 1 Insulation
- 2 Thermocouple
- 3 Sinter tray
- 4 Display
- 5 Frame plate
- 6 Sinter chamber
- 7 Furnace housing
- 8 Membrane-sealed keypad
- 9 On/Off switch
- 10 Heater fuse
- 11 Fuse holder
- 12 Power cord
- 13 Power socket
- 14 Rating plate
- 15 Rubber foot
- 16 Furnace head housing
- 17 Thermocouple plug
- 18 Power electronics plug
- 19 Plug fuse
- 20 Heater plug
- 21 Socket for the heater plug
- 22 Socket for the thermocouple plug
- 23 Socket for the power electronics plug
- 24 Leave spring
- 25 Air vents base
- 26 Cooling tray
- 27 Cooling tray fastening screw
- 28 Silicone washer
- 29 Hood
- 30 Attachment screw for hood
- 31 Air vents furnace head
- 32 Air vents rear panel
- 33 Furnace head mounting mark
- 34 Furnace base mounting mark
- 35 Furnace head mounting
- 36 Heating element
- 37 Sinter tray rest
- 38 Thermocouple cable
- 39 Power electronics cable
- 40 Connecting rod axis
- 41 Plug-in console
- 42 USB device interface
- 44 OSD indicator
- 45 Spacer
- 46 Grounding band
- 47 Screw for grounding band



Please note that the list of parts applies to the entire Operating Instructions. These parts and their numbers are often referred to in later chapters.

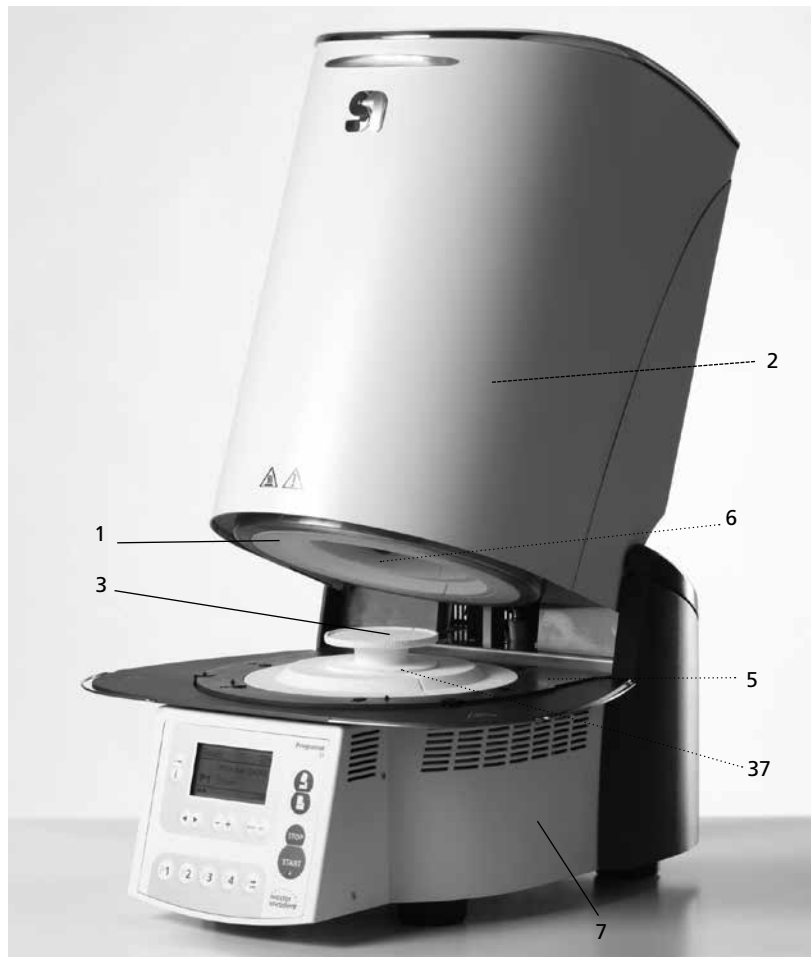
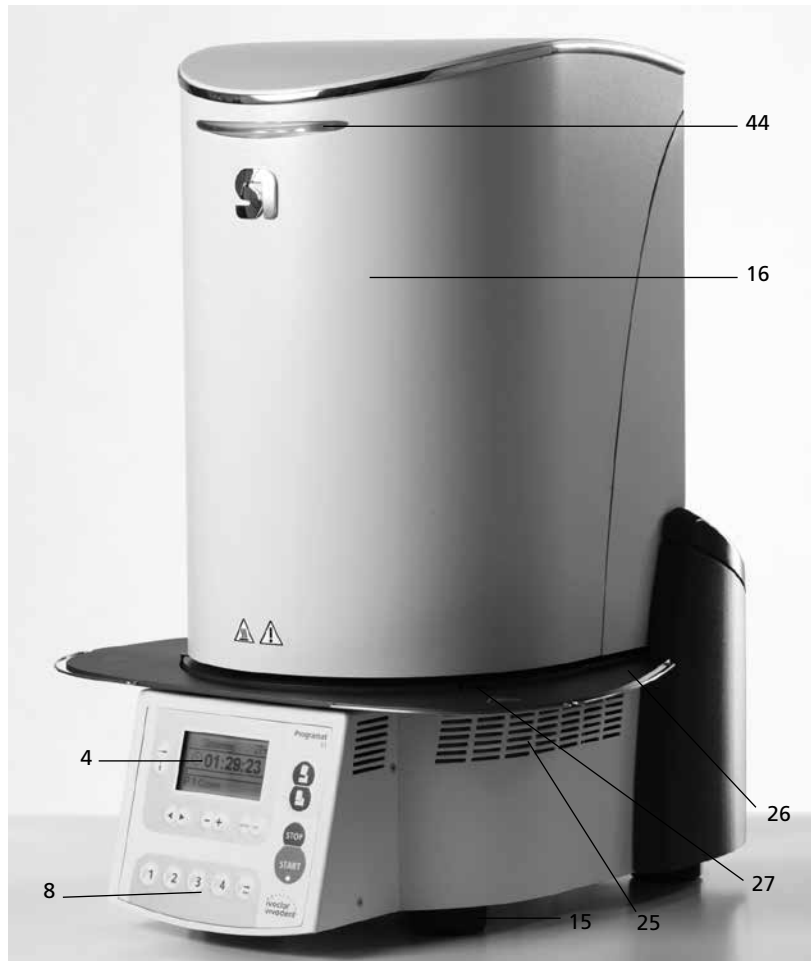

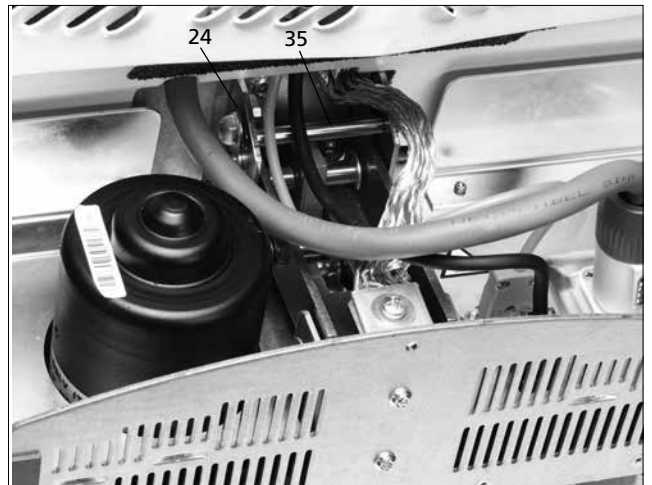
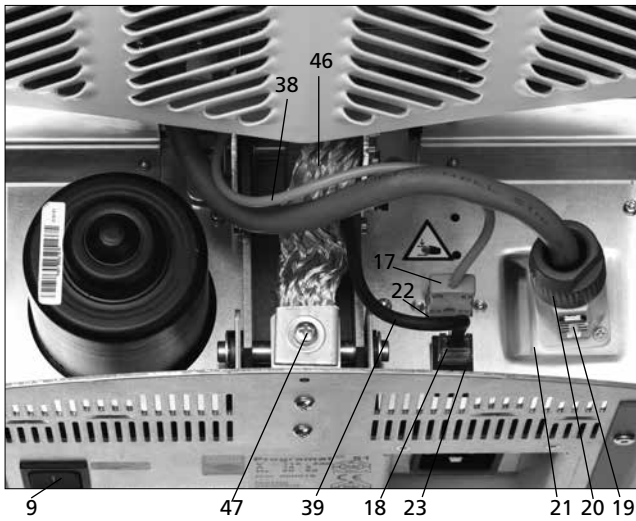
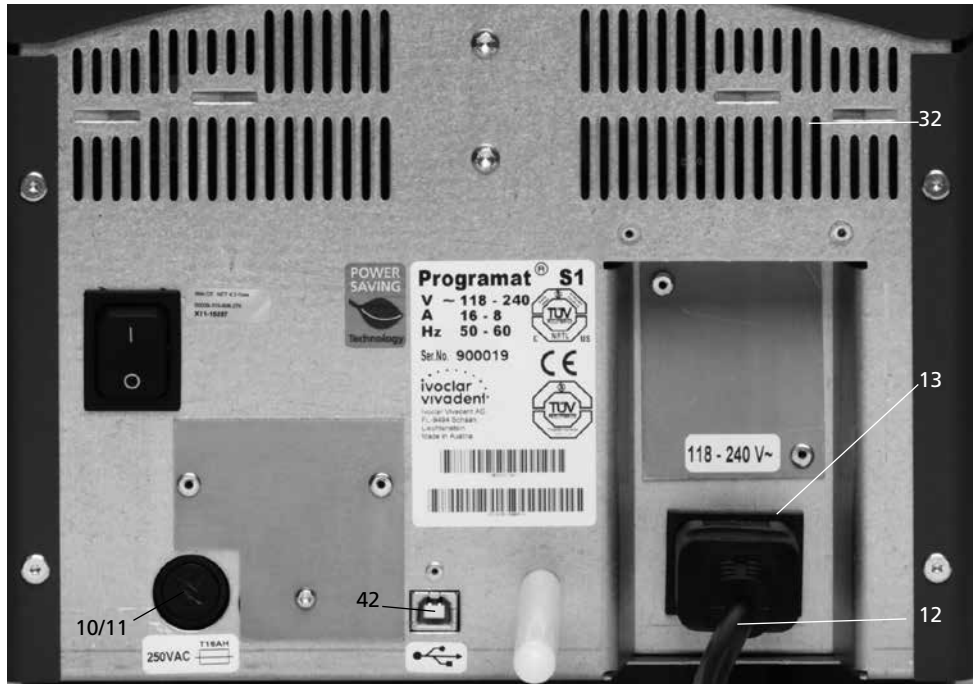
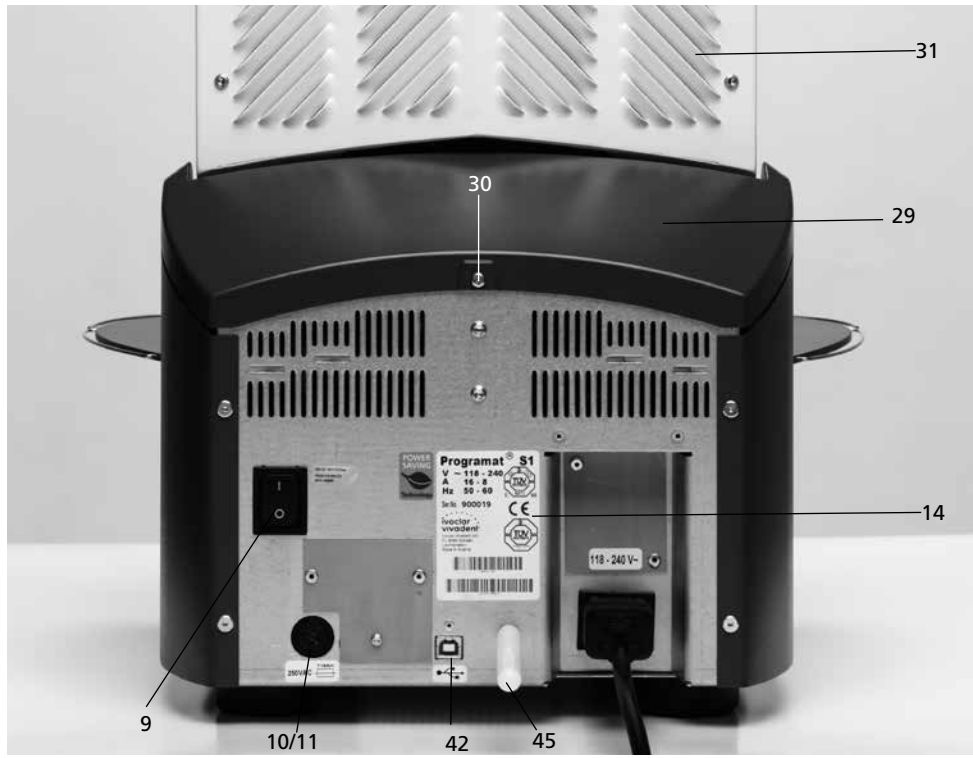

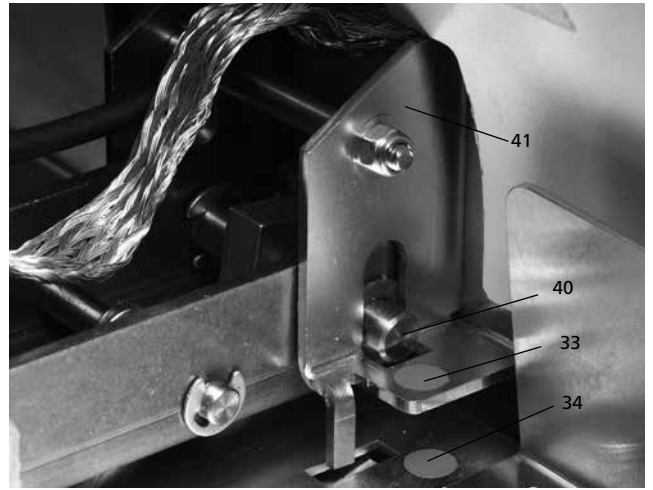
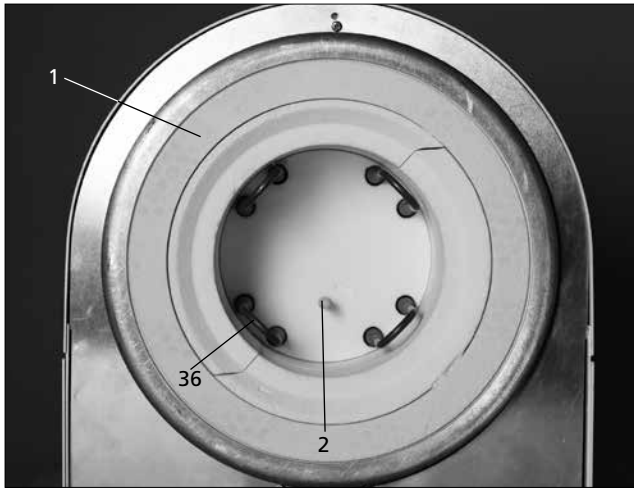

Operating unit:

- 71 ESC key
- 72 ENTER key
- 73 Start key
- 74 Start LED
- 75 Stop key
- 76 + key
- 77 - key
- 78 Settings key
- 79 Cursor right key
- 80 Cursor left key
- 81 Information key
- 82 Program 1 key
- 83 Program 2 key
- 84 Program 3 key
- 85 Program 4 key
- 86 Next program key
- 87 Open furnace head
- 88 Close furnace head

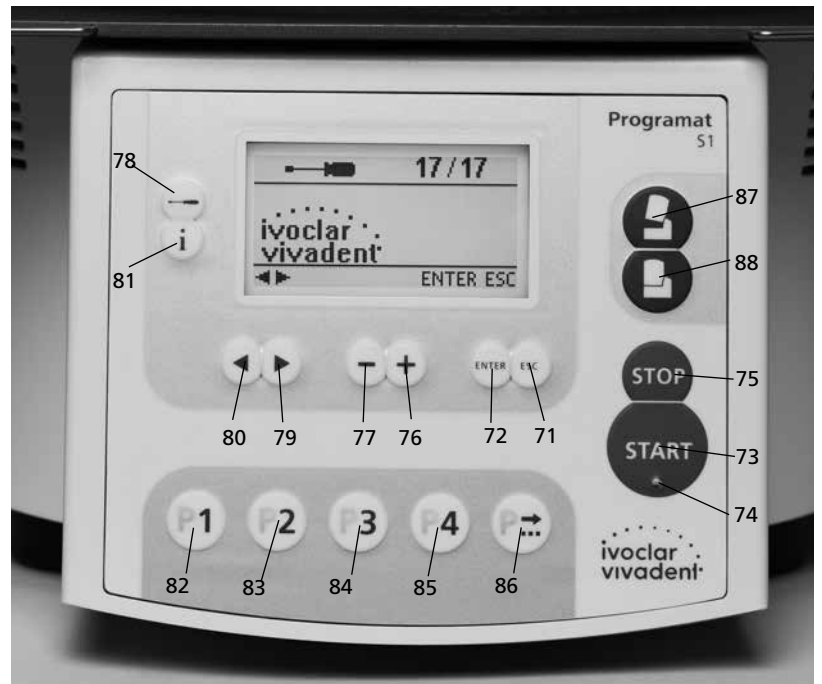

100 Sinter tray

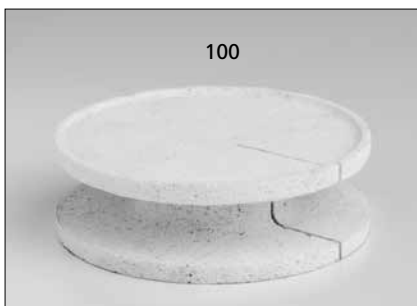

101 Sinter tray fork

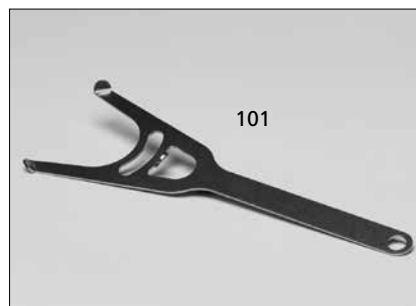

102 Cleaning brush

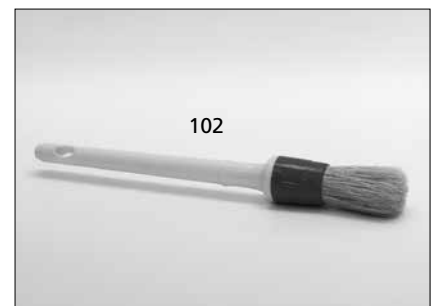

1. Introduction / Signs and Symbols

1.1 Preface

Dear Customer

Thank you for having purchased the Programat S1. It is a sinter furnace for **dental laboratories** requiring such a furnace for the CAD/CAM technique. The Programat S1 permits the sintering of ZrO₂ materials. It has been especially designed and constructed for this purpose.

The furnace has also been designed according to the latest industry standards. However, inappropriate use may damage the equipment and be harmful to personnel. Please observe the relevant safety instructions and read these Operating Instructions carefully.

Enjoy working with the Programat S1.

1.2 Signs and symbols

The signs and symbols in these Operating Instructions facilitate the finding of important points and have the following meanings:



Risks and dangers



Important information



Contraindication



Burn hazard



Risk of crushing

1.3 Notes regarding these Operating Instructions

Furnace concerned: Programat S1
Target group: Dental technologists

These Operating Instructions facilitate the correct, safe and economic use of the Programat S1 furnace.

Should you lose the Operating Instructions, extra copies can be ordered at a nominal fee from your local Ivoclar Vivadent Service Center or downloaded from the Internet free of charge (www.ivoclarvivadent.com).

1.4 Notes regarding the different voltage versions

The furnace has been designed for the following voltage range:

118–240V / 50-60 Hz

No manual switch-over is required for the use of the different voltage versions. Make sure that the local power supply complies with the voltage indicated on the rating plate before operating the furnace.

2. Safety First

This chapter is especially important for personnel who work with the Programat S1 or who have to carry out maintenance or repair work. This chapter must be read and the corresponding instructions followed.

2.1 Indications

The Programat S1 is intended to sinter ZrO_2 ceramic materials used in dentistry and it should be used for this purpose only. Other uses than the ones stipulated, e.g. cooking of food, firing of other materials etc., are contraindicated. The manufacturer does not assume any liability for damage resulting from misuse. The user is solely responsible for any risk resulting from failure to observe these Instructions.

Further instructions to assure proper use of the furnace:

- The instructions, regulations and notes in these Operating Instructions must be observed.
- The instructions, regulations and notes in the material's Instructions for Use must be observed.
- The furnace must be operated under the indicated environmental and operating conditions (see Chapter 9).
- The Programat S1 must be properly maintained.



Do **not** use colouring liquids containing chlorine or hydrochloric acid in Programat S1 furnaces. Due to the aggressive components of the liquids, the furnace surface or individual parts may be chemically corroded or damaged.

If colouring liquids containing chlorine or hydrochloric acid are used, irritating gases may develop during the heating phase. These gases pose a risk to users particularly when infiltrated frameworks are not correctly pre-dried.

2.1.1



Contraindication

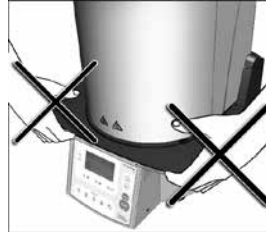

The furnace must not be carried by the cooling tray.

2.1.2



Contraindication

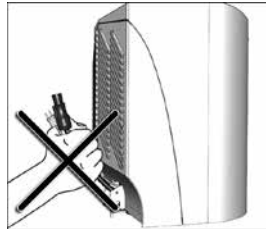

The furnace head must not be carried by the cables, since cables and connections may be damaged by such action.

2.1.3



Contraindication



The furnace head must not be removed from the furnace head while it is still connected to the heater cable.

2.1.4



Contraindication



The furnace head is equipped with an electric drive and can be operated by means of the electronic controls. Never open the furnace head by hand, since this will damage the transmission.

2.1.5



Contraindication



Do not touch the thermocouple and the heating element in the sintering chamber. Avoid skin contact (grease contamination), since this will speed up the degradation of the components.

2.1.6



Contraindication



Never use the furnace without the sinter tray. Use only the original S1 sinter tray. Do not use the firing trays or honey-combed trays from conventional ceramic furnaces. Furthermore, check the sinter tray for damage, cracks or contamination before every sintering cycle. If the table is damaged, it must no longer be used. A maximum of one sinter tray is to be placed in the sintering chamber. Do not stack the sinter trays.

2.1.7



Contraindication



Firing trays must not be placed in the area surrounding the firing table, since this will obstruct the closing of the furnace head.

2.1.8



Contraindication



Foreign objects must not be placed on the furnace head or the air vents. Make sure that no liquids or other foreign objects enter the air vents, since this may result in an electrical shock.

2.1.9



Contraindication

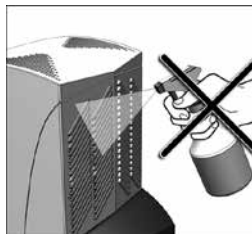

Make sure that no liquids or other foreign objects enter the furnace.

2.1.10



Contraindication

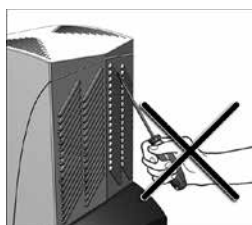

Do not insert any foreign objects into the air vents. There is a risk of electrical shock.

2.1.11



Burn hazard

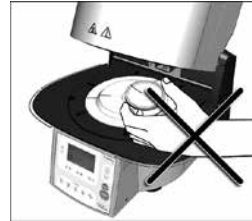

Never place objects in the sintering chamber by hand, since there is a burn hazard. Always use the sinter tray fork (accessories) supplied for this purpose. Never touch the hot surface of the furnace head, as there is a burn hazard. Please also refer to the warnings on the furnace.

2.1.12



Risk of crushing and burn hazard



Never reach under the furnace head with the hand or other parts of the body during operation, since there is a risk of crushing and a burn hazard.

2.1.13



Risks and dangers

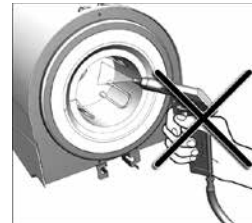

This product contains ceramic fibres and may release fibre dust. Do not use compressed air, or blow, on the furnace, thus distributing the dust in the environment, and observe the additional notes on page 11.

2.1.14



Risks and dangers

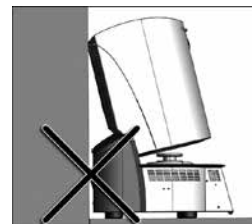

Do not use the furnace without spacer, since the distance to the back wall has to be kept!

2.1.15



Risks and dangers

The furnace must not be operated if the heating element in the sintering chamber is damaged. There is a risk of electric shock upon contact with the heating wire.

2.1.16



Contraindication



For safety reasons, the furnace must not be operated without the cooling tray.

2.1.17



Risks and dangers

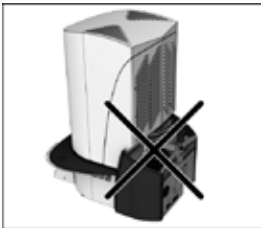

The furnace must not be connected to the power supply without the rear cover in place.

2.2 Health and Safety Instructions

This furnace has been designed according to EN 61010-1 and has been shipped from the manufacturer in excellent condition as far as safety regulations are concerned. To maintain this condition and to assure risk-free operation, the user must observe the notes and warnings contained in these Operating Instructions.

- The user must especially become familiar with the warnings and the operating conditions to prevent injury to personnel or damage to materials. The manufacturer is not responsible for damage resulting from misuse or failure to observe the Operating Instructions. Warranty claims cannot be accepted in such cases.
- Before switching on the furnace, make sure that the voltage indicated on the rating plate complies with your local power supply.
- The power socket must be equipped with a residual current circuit breaker.
- The furnace must be plugged into a socket with protected contacts.
- Place furnace on a fire-proof table (observe local regulations, e.g. distance to combustible substances or objects etc.)
- Always keep the air vents at the rear and the side of the furnace free from obstruction.
- Do not touch any parts that become hot during the operation of the furnace. There is a burn hazard!
- Clean furnace only with a soft, dry cloth. Do not use solvents! Disconnect power before cleaning and allow the furnace to cool down!
- The furnace must be cool before it is packed for transportation purposes.
- Use original packaging for transportation purposes.
- Before calibration, maintenance, repair or exchange of parts, the furnace must be cooled down and the power disconnected if the furnace is to be opened.

- If calibration, maintenance or repair has to be carried out with the power connected and the furnace open, only qualified personnel from the field of electrical engineering who are familiar with the risks and dangers may perform these procedures.
- After maintenance, the required safety tests (high voltage resistance, protective conductor etc.) have to be carried out.
- Ensure that only fuses of the indicated type and rated current are used.
- If it is assumed that safe operation is no longer possible, the power must be disconnected to avoid accidental operation. Safe operation is no longer possible if
 - the furnace is visibly damaged
 - the furnace does not work
 - the furnace has been stored under unfavourable conditions over an extended period of time
- Use only original spare parts.
- The temperature range for faultless operation is +5 °C to +40 °C (+41 °F to +104 °F).
- If the furnace has been stored at very low temperatures or high atmospheric humidity, the head has to be opened and the furnace dried or left to adjust to room temperature for approximately 4 hours (do not connect the power yet).
- The furnace has been tested for use at altitudes of up to 2000 m (6562 ft) above sea level.
- The furnace may only be used indoors.
- Before leaving the factory, the furnace functions were tested for several hours. It is therefore possible that these tests have caused slight discolouration of the insulation. Nevertheless, your Programat S1 is still a brand new furnace.



Any disruption of the protective conductor either inside or outside the furnace or any loosening of the protective conductor connection may lead to danger for the user in case of malfunction. Deliberate interruptions are not tolerated.



Materials developing harmful gases must not be fired.

Warning regarding the removal of the sintering chamber



This product contains ceramic fibres and may release fibre dust. Fibre dust has proved to be carcinogenic in animal experiments. The sintering chamber must only be disassembled by a certified After Sales Service Center. Information regarding the Safety Data Sheet is also available from your Service Center.

Warning

The insulation on this product contains refractory ceramic fibres (RCF), which pose a possible cancer hazard, if agitated and inhaled. May be irritating to the skin, eyes or respiratory tract if insulation is cracked or corrupted.

California Proposition 65

Warning: "This product contains Refractory Ceramic Fibres, a substance known to the State of California to cause cancer."

Disposal:



The furnaces must not be disposed of in the normal domestic waste. Please correctly dispose of old furnaces according to the corresponding EU council directive. Information on the correct disposal may also be found on your local Ivoclar Vivadent home-page.

3. Product Description

3.1 Components

The Programat S1 consists of the following components:

- Furnace base with electronic controls
- Furnace head with sintering chamber
- Sinter tray
- Cooling plate
- Sinter tray fork
- Cleaning brush

3.2 Hazardous areas and safety equipment

Description of the hazardous areas of the furnace:

Hazardous area	Type of risk
Sintering chamber	Risk of burning
Opening and closing mechanism	Risk of crushing
Electrical components	Risk of electrical shock

Description of the safety equipment of the furnace:

Safety equipment	Protective effect
Protective conductor	Protection from electrical shock
Electrical fuses	Protection from electrical shock
Furnace housing and covering ends	Protection from electrical shock, burning and crushing

3.3 Functional description

The sintering chamber may be heated up to max. 1530 °C (2786 °F) by means of a heating element. The sintering process is controlled with the corresponding electronic controls and software. Moreover, the set and actual temperatures are continuously compared.

3.4 Accessories

- Temperature Checking Set S1

3.5 Indication / contraindication

Indication

- Sintering of ZrO₂ materials

Contraindication

- The Programat S1 is not suitable as a ceramic furnace for dental laboratories.

4. Installation and Initial Start-Up

4.1 Unpacking and checking the contents

The packaging provides the following advantages:

- Reusable packaging
- Closing mechanism with integrated transportation grips
- Ideal protection by Styrofoam inserts
- Easy handling / optimum unpacking
- The packaging may be used in several ways (modules)

Remove the furnace components from their packaging and place it on a suitable table. Please observe the instructions on the outer packaging.

There are no special transportation grips on the furnace. Support the bottom of the furnace to carry it.

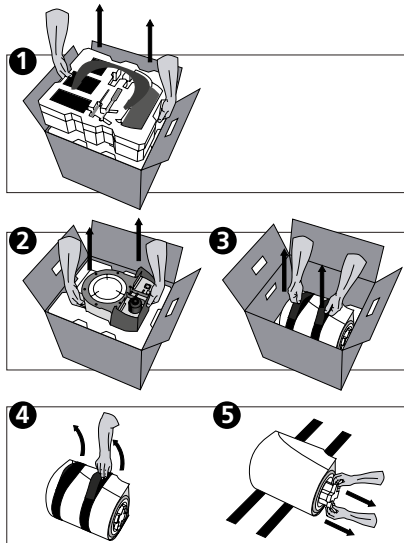

Check the delivery for completeness (see delivery form in Chapter 9) and transportation damage. If parts are damaged or missing, contact your local Ivoclar Vivadent Service Center.

Packing and shipping of individual components

The packaging of the S1 permits simple and safe shipping of individual components. Simply use the two corresponding inserts. Fold the side flaps (2) and combine the two packaging parts by means of the transportation flaps. The packaging may be disposed of with the regular household refuse.

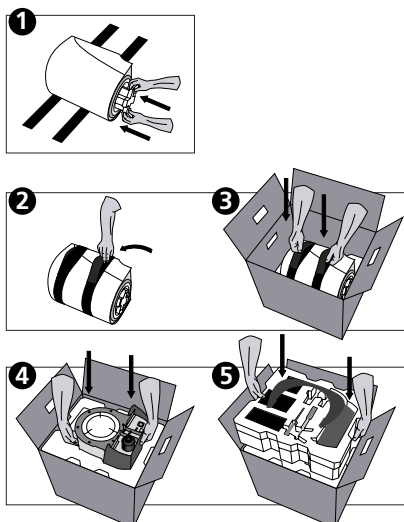

We recommend keeping the original packaging for future service and transportation purposes.

4.2 Selecting the location

Place the furnace on a flat table using the rubber feet. Make sure that the furnace is not placed in the immediate vicinity of heaters or other sources of heat. Make sure that air may properly circulate between the wall and the furnace and that there is enough space for the swivel movement of the furnace head (at least 110 mm). Therefore, mounting the spacer (45) is absolutely mandatory.

Also ensure that there is enough space between the furnace and the user, as the furnace releases heat during the opening of the furnace head.

The furnace should neither be placed nor operated in areas where there is an explosion hazard.

4.3 Assembly

Make sure the voltage indicated on the rating plate (14) complies with the local power supply. If this is not the case, the furnace must not be connected.



Step 1: Assembling the cooling tray (26)

Remove both screws (27) including the silicone washer (28).



Place the cooling tray (26) on the frame plate (5). Make sure that the cooling tray (26) is correctly positioned on the frame plate (5) and that the danger symbols are visible from above.



Secure the cooling tray (26) with the two screws (27) including the silicone washer (28).



**Step 2:
Mounting the spacer**

The spacer (45) can be mounted to the rear of the furnace with the help of the fastening pin intended for this purpose. Press the spacer strongly against the rear of the furnace. For safety reasons, the spacer must always be mounted.



Step 3:

Mounting the furnace head

The complete furnace head is best mounted with the rear panel of the furnace pointing towards the user. Lift the furnace head with both hands as shown in the picture (with the rear hand gripping the holding area lined with sandpaper on the furnace head), and carefully position it on the furnace head mounting (35).



Ensure that the furnace head mounting mark (33) is aligned with the furnace base mounting mark (34).



Make sure that the sinter chamber and the insulation (5) are not damaged by mounting the furnace head.



Step 4:

Attaching the grounding band

Attach the grounding band (46) to the corresponding connection of the furnace housing using the screw for the grounding band (47).



**Step 5:
Connections**

Connect the cables of the furnace head with the furnace base. Proceed as follows:

- Insert the thermocouple plug (17) (make sure that the polarity of the plug is correct)
- Insert the heater plug (20)
- Insert the power electronics plug (18)

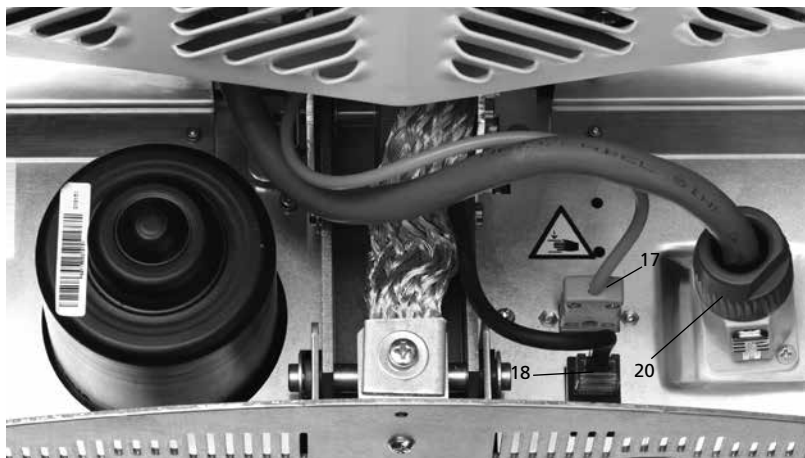

Secure the heater plug (20) by turning it until the heater plug (20) has been secured.

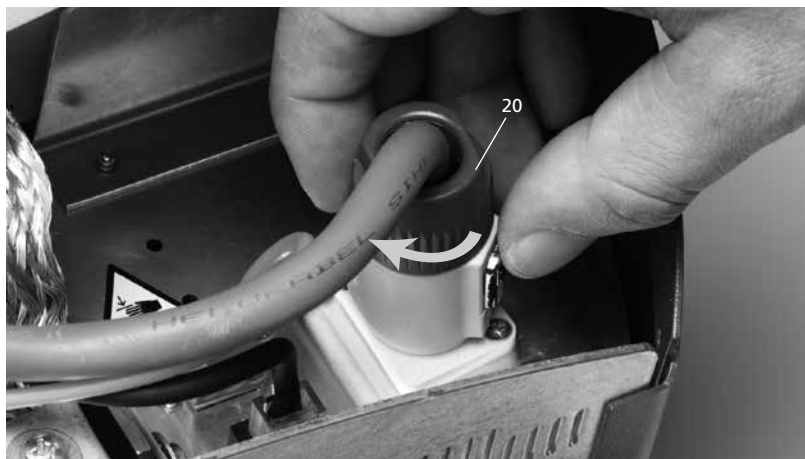

**Step 6:
Mounting the hood (29)**

Once all cables are properly connected to the furnace base, the hood (29) can be mounted.

Subsequently, secure the hood with the knurled screw (30).



The furnace may only be operated with the hood mounted.

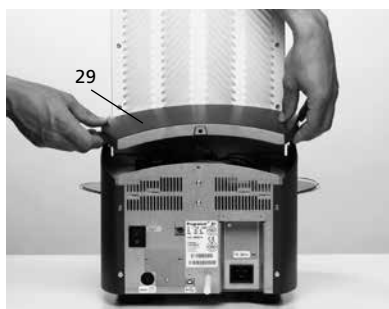

**Step 7:
Establishing additional connections**

Power connection

Please make sure that the voltage indicated on the rating plate complies with the local power supply. Connect the power cord (12) with the power socket (13) of the furnace.



4.4 Removing the furnace head

Before the hood (29) is removed, the furnace has to be switched off, cooled down and the power cord (12) disconnected from the power socket (13).

1. Loosen the attachment screw (30) for the hood (29) and remove it
2. Remove the hood
3. Disconnect the thermocouple plug (17)
4. Disconnect the heater plug (20)
5. Disconnect the power electronics plug (18)
6. Loosen and remove the grounding band (46)
7. Press the leaf spring (24) with a finger, lift off the furnace head at the same time and remove it



Make sure the furnace head has completely cooled down before it is removed (fire hazard).



4.5 Initial start-up

1. Connect the power cord (12) with the wall socket
2. Put the On/Off switch (9) at the rear of the furnace on position "I"

The furnace will now automatically conduct a self-test. The performance of all furnace components is automatically checked. The display shows the following indications during the self-test:



- a) Progress bar
- b) Firing hours
- c) Software version
- d) Current supply voltage

If any component is defective, the corresponding error number (ER xxx) will be indicated in the display. If everything is in working order, the display will change to the stand-by indication.

Stand-by indication

The stand-by indication is shown after the self-test. The last program used before the furnace was switched off is loaded.

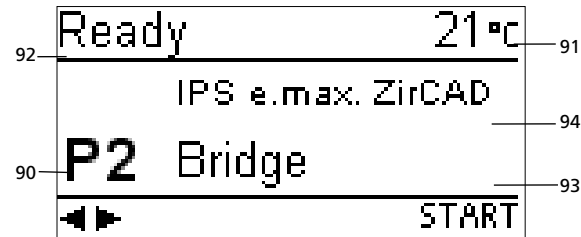

- 90 Program number
- 91 Current temperature
- 92 Furnace status
- 93 Program name
- 94 Material name

5. Introduction to the Operation

5.1 Introduction to the operation

The Programat S1 is equipped with a graphic display with backlighting. The numeric and command keys can be used to program and control the furnace.

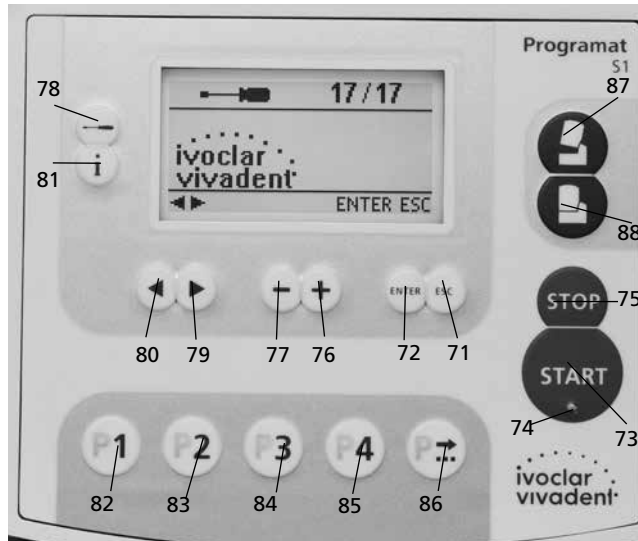

– Open furnace head key (87)

Furnace head is opened (not during a program in progress, or if the temperature in the sintering chamber is higher than 600°C/1112°F).

– Close furnace head key (88)

Furnace head is closed (not during a program in progress).

– Program 1 key (82)

Program 1 (P1) is selected with this key (not during a program in progress).

– Program 2 key (83)

Program 2 (P2) is selected with this key (not during a program in progress).

– Program 3 key (84)

Program 3 (P3) is selected with this key (not during a program in progress).

– Program 4 key (85)

Program 4 (P4) is selected with this key (not during a program in progress).

– Next program key (86)

The next program (P5, P6) is selected with this key (not during a program in progress).

5.2 Explanation of the key functions

– Settings key (78)

After pressing the Settings key, the settings required for the furnace can be displayed one after the other and changed, if necessary.

– Information key (81)

After pressing the Information key, information about the furnace can be displayed one after the other.

– Cursor keys (79, 80)

In the stand-by display, the cursor keys can be used to change the program. The cursor keys are also used to scroll through the settings or information pages.

In the parameter list, the current cursor position is indicated by a solid (non-flashing) frame around the numeric value.

– +/- keys (76, 77)

Changing the settings or entering a numeric value is achieved by means of the +/- keys.

Each entry by means of the – or + key is immediately accepted, provided the corresponding value range is observed. Once the value range limit has been reached, the value can no longer be changed.

– ESC key (71)

This key is used to end the error display. Furthermore, any page of the display can be left with this key.

– ENTER key (72)

With this key, settings may be changed or entries confirmed.

– Start key (73)

This key starts the selected program.

– Start LED (74)

Lights up once a program has started. It flashes when the program is paused.

– Stop key (75)

Pressing 1 x (pause program)

Pressing 2 x (program is aborted)

The STOP key also stops the furnace head movement and the acoustic signal.

5.3 Basic meaning of the display elements

– Stand-by

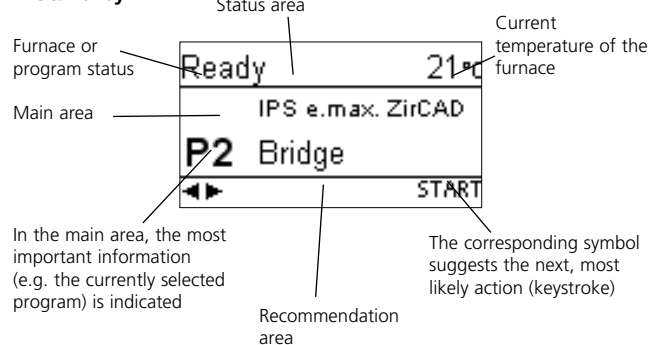

– Program

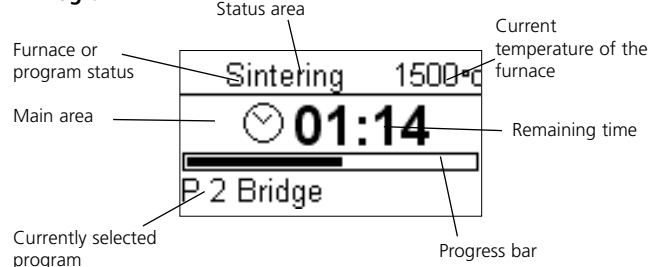

5.4 Program structure

The sinter furnace basically offers two types of programs:

a) Standard program for materials of the Ivoclar Vivadent group (see enclosed Program Table)
e.g. IPS e.max ZirCAD, Zenostar T, etc.

b) Free programs

All the free programs are equal and available as full-fledged programs. All the parameters can be individually set in each program.



When the furnace is delivered ex works, the standard programs already contain the recommended material parameter settings.

The programs have been designed in such a way that the 3 heating stages, 2 cooling stages, and 1 opening time can be set.

5.5 Adjustable parameters and possible value ranges

Symbol	Parameters		Value range °C			Value range °F		
			min	max	Unit	min	max	Unit
b	Heating stage 1	Temperature increase rate	5	90	°C/min	2	162	°F/min
T1		Holding temperature	700	1200	°C	1292	2192	°F
H1		Holding time	00:00	05:00	hh:mm	00:00	05:00	hh:mm
t2	Heating stage 2	Temperature increase rate	1	50	°C/min	2	90	°F/min
T2		Holding temperature	0/700	1530	°C	0/1292	2786	°F
H2		Holding time	00:00	05:00	hh:mm	00:00	05:00	hh:mm
t3	Heating stage 3	Temperature increase rate	1	50	°C/min	2	90	°F/min
T3		Holding temperature	0/700	1530	°C	0/1292	2786	°F
H3		Holding time	00:00	05:00	hh:mm	00:00	05:00	hh:mm
t4	Cooling stage 1	Temperature decrease rate	1	50	°C/min	2	90	°F/min
T4		Holding temperature	100	1100	°C	121	2012	°F
H4		Holding time	00:00	05:00	hh:mm	00:00	05:00	hh:mm
t5	Cooling stage 1	Temperature decrease rate	1	50	°C/min	2	90	°F/min
T5		Holding temperature	0/100	1100	°C	0/212	2012	°F
H5		Holding time	00:00	05:00	hh:mm	00:00	05:00	hh:mm
O	Opening time	Opening time	00:15	05:00	hh:mm	00:00	05:00	hh:mm

Automatic plausibility check of the parameters

The furnace is equipped with an automatic plausibility check function. The parameters are checked upon each program start. In case of contradictory parameter combinations, the program stops automatically and the respective error number is indicated.

Graphic overview of the program parameters

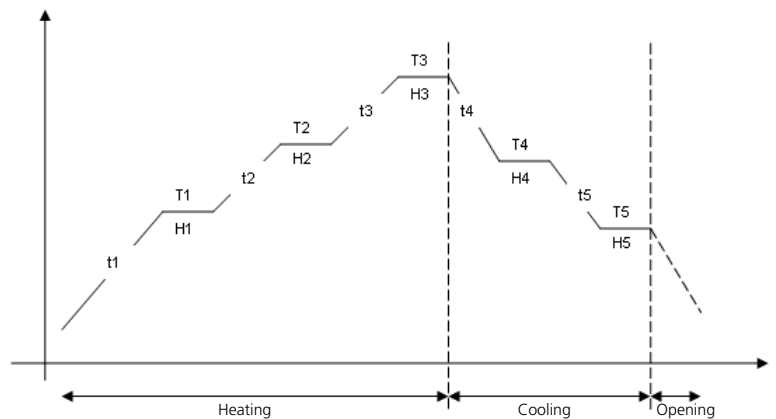

5.6 Settings / test program and information

By pressing the Settings key (78) you will reach the setting screen (the latest setting selected will be shown).

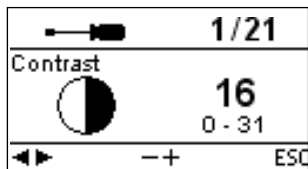

The cursor keys (79, 80) can be used to toggle between the possible settings. This screen can be left by pressing ESC (71) or by pressing one of the program keys (82, 83, ...).

5.6.1 Settings / test programs

Settings	Display	Short Description
Contrast		The contrast can be adjusted with the -/+ keys.
Temperature unit		The -/+ keys are used to toggle between °C and °F.
Language selection		Enables the language selection.
Temperature calibration		With this program, the temperature calibration program can be started. See Chapter 7.5 Temperature Calibration for more details.
Volume		The desired volume can be set using the -/+ keys
Tune		The desired tune may be set using the -/+ keys
Programming		Enables the programming of the parameters for the currently selected program *
Renaming		Enables the renaming of the currently selected program *
		Enables the renaming of the material
Time		The time can be set using the -/+ keys

Settings	Display	Short Description
Date		The date can be set using the -/+ keys
General write protection		Enables the activation or deactivation of the general write protection by means of the -/+ keys after entering the user code. The write protection covers all programs
Heater test program		Enables a check of the heating system
Keypad test		Enables a check of the membrane-sealed keypad
Cleaning program		With this program, the heating muffle, including the insulation materials, can be cleaned by means of a heat process
Protocol		Enables the creation of protocols of the sintering procedures
Start delay		Activating this function enables the delayed start of sintering programs
Operating Status Display		With this menu item, the Operating Status Display can be activated/deactivated
Service interval		Select the interval for the next reminder. The intervals are set in months.
Load factory settings		With this setting option, all the values and parameters can be reset to the original factory settings. Note: All the individual programs that you have generated and saved will be deleted by this function





Important information

For certain settings, the user code (359) is required.





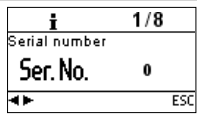

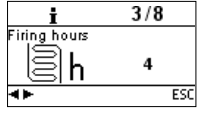
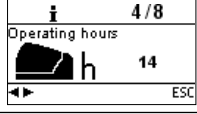
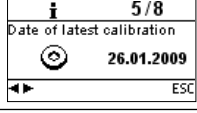
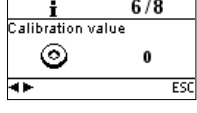
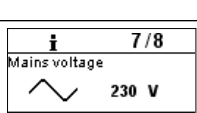
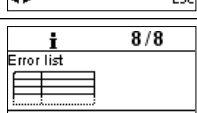
* Some programs (P1–P7) are protected with a code. If changes are necessary, the corresponding code will be provided.

5.6.2 Information

By pressing the Information key (81), you will reach the information screen (the last selected information is displayed). The cursor keys (79, 80) can be used to toggle between the possible information. This screen can be left with the ESC key (71) or one of the program keys (82, 83, ...).

Settings	Display	Short Description
Serial number		Serial number of the furnace
Software version		
Furnace head firing hours		
Furnace operating hours		
Last start of the calibration program		
Calibration value		Calibration value at 1500 °C/2732 °F. The value is displayed in accordance with the selected temperature mode in °C or °F.
Supply voltage		Shows the current supply voltage
Error list		Enables the display of the last error messages.

5.7 Explanation of the symbols in the display

Symbol Name	Meaning	Symbol
Open furnace head	Shown in the recommendation area, where the next most likely action is suggested.	
Close furnace head	Shown in the recommendation area, where the next most likely action is suggested.	
Press START	Shown in the recommendation area, where the next most likely action is suggested.	START
Press STOP	Shown in the recommendation area, where a possible action is suggested.	STOP
Press ENTER	Shown in the recommendation area, where a possible action is suggested.	ENTER
Press ESC	Shown in the recommendation area, where a possible action is suggested.	ESC
Use cursor keys	Shown in the recommendation area, where a possible action is suggested.	
Use +/- keys	Shown in the recommendation area, where a possible action is suggested.	- +
General write protection	Shows in the parameter list that the general write protection for all programs has been activated by means of the user code.	
Individual write protection active	Shows in the parameter list that the individual write protection for this program is active.	
Individual write protection not active	Shows in the parameter list that this program is not write-protected.	

5.8 Explanation of the acoustic signal

Basically, all the acoustic signals are played using the tune and volume selected by the user.

The acoustic signal can only be stopped by pressing the STOP key.

- **After the self-test has been completed**

In order to inform the user that the automatic self-test has been successfully completed, an acoustic signal is played.

- **In case of error messages**

Error messages are acoustically supported by the error tune (endless). The beeper may be stopped with the STOP key, while the error message remains visible in the display. If the error message is acknowledged with ESC, the beeper also stops.

- **At the end of a program**

In order to inform the user that the sintering process has been completed, an acoustic signal is played.

5.9 OSD

The OSD (Optical Status Display) integrated in the furnace head shows the most important statuses of the furnace. The following activities are shown:

Colour	Activity
green	Furnace is ready for use (self-test has been completed)
red	Sintering process active, furnace busy
yellow (flashing)	Information, notification or error message

6. Practical Use

The operating procedure for the Programat S1 will be explained with the help of two examples: one standard and one individual program.

6.1 Switching on the furnace

Put On/Off switch (9) on position „I“. The furnace conducts an automatic self-test, which will be indicated in the beginning. Subsequently, a status bar shows the progress of the self-test. Make sure that the furnace is not manipulated during this time.

6.1.1 Stand-by screen

If the self-test has been successful, the stand-by screen will appear in the display and the desired program can be selected using the program selection keys.

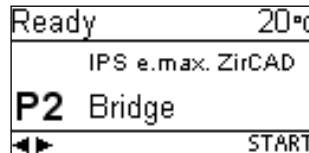

Once the furnace head has been opened and the loaded sinter tray placed, the program can be started using the START key. For that purpose, the START key is shown in the recommendation area.

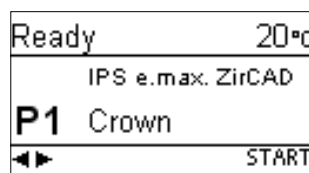

Note:
For safety reasons, the furnace head can only be opened once the temperature has dropped below 600 °C/1112 °F.

6.1.2 Program progress indicator

When the program is started using the START key, the program progress indicator is shown in the display.

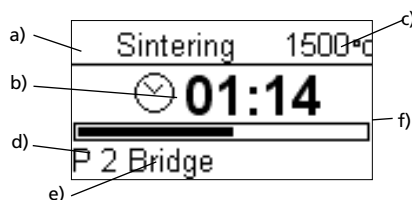

The following information is provided:

- a) Program status
- b) Remaining time (hh:mm)
- c) Current temperature
- d) Program number
- e) Program name
- f) Progress bar

6.2 Loading the Programat S1

The sinter tray (100) holds up to approximately 20 single-tooth restorations. Make sure that the objects do not touch in order to prevent them from sintering together. The ZrO₂ sinter beads are usually not required for this process.

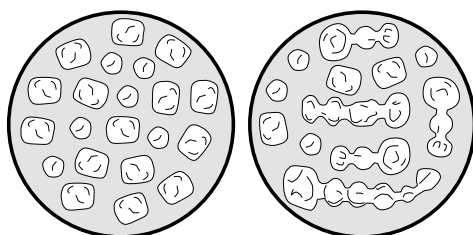

In case of stack milling, the individual objects have to be separated from the stack, the corresponding margins adjusted and the attachment points smoothed out by grinding.

CAD/CAM fabricated support structures (for large frameworks with a pronounced curvature) should not be separated for the sintering process. In order to achieve optimum sintering results, the objects should be placed on their occlusal or labial surface (not on the cervical margin). Furthermore, no objects should be placed on the groove in the sinter tray, if possible. After that, the sinter tray is placed in the center of the sinter chamber by means of the sinter tray fork (101).

i Please read the following processing notes very carefully

The individual pre-drying times of the ZrO₂ objects must be observed. They depend on the size of the restoration and the pre-drying temperature. For more detailed information, please refer to the instructions for use of the corresponding material.

i If the Colouring Liquids are used, several points must be observed:

- The restorations stained with Colouring Liquid must be adequately pre-dried in a pre-drying furnace. Air drying is not sufficient in these cases and may result in cracks in the objects during the sintering process.
- After the sintering process, clean contaminated areas of the furnace with a soft cloth.
- In case of severe contamination of the sinter chamber or the insulation, conduct a cleaning firing.

Once the sintering process is completed, the sinter tray is removed from the furnace using the sinter tray fork. If the tray is placed on the cooling tray, make sure that it is securely positioned.



Warning icon: For safety reasons, always use the sinter tray fork when placing the sinter tray in or removing it from the furnace.

6.3 Sintering using a standard program

Step 1:

Select the desired program using the program keys.

i **Warning icon:** **Note**
If the sintering program has been aborted, the furnace head can be only opened once the temperature has dropped below 600 °C/1112 °F.

Step 2:

Open the furnace head using the Open furnace head key (87) and place the loaded sinter tray into the furnace.

Step 3:

Press the Start key (37) and the program will start. You can observe the cycle on the program progress indicator.

6.4 Sintering using an individual program

Step 1:

Select a free program.

Step 2:

Select the parameters list via Settings – Programming, and then change the program parameters using the +/- keys. Then return to the stand-by screen using ESC or a program key.

P 5		+2.
t1 90	T1 1200	H1 00:00
t2 10	T2 1300	H2 00:00
t3 60	T3 1500	H3 00:01

Schritt 3:

Open the furnace head using the „Open furnace head“ key (87) and place the loaded sinter tray into the furnace. Press the Start key (37) and the program will start. You can observe the cycle on the program progress indicator.

Sintering	559°C
	00:57
P 8 Individual	

6.6 Programming*

The parameter list can be selected via Settings – Programming. This list contains all the program parameters. The desired parameter is selected with the cursor keys. The value is adjusted using the +/- keys. This screen can be left by pressing ESC or one of the program keys.

The parameters for heating and cooling stages are located in a separate program stage screen. Please refer to „Operation and configuration“ for explanations of the parameters.

P 4		+2.
t1 90	T1 1200	H1 00:00
t2 10	T2 1300	H2 00:00
t3 60	T3 1500	H3 01:00

P 4		
t4 20	T4 1200	H4 00:00
t5 0	T5 0	H5 00:00
O 00:00		

Symbol „Change to program stage screen“

If the cursor is placed on the „Change program stage screen“ symbol, pressing ENTER permits changing the program stage screen. The holding times and the opening time are entered in hh:mm.

* The standard programs are protected by a code. If changes are necessary, the corresponding code is provided.

6.5 Additional possibilities and special features of the furnace

6.5.1 General write protection

If all programs are write-protected, a closed, black lock appears. The setting ‚Renaming‘ cannot be selected if the general write protection is activated. As an indication, a closed lock is shown next to the keyboard symbol.

6.5.2 Stopping the running program

A program in progress can be paused by pressing the STOP key once. If a program has been paused, the green LED in the START key flashes. Furthermore, the status shows as „Pause“. By pressing STOP a second time, the program can be aborted. It can be resumed by pressing START.



Note

If the sintering program has been aborted, the furnace head can be only opened once the temperature has dropped below 600 °C/1112 °F.

6.5.3 Individual program write protection

For standard programs, the individual program write protection is activated by default to prevent accidental changes of the parameters.

The individual program write protection (symbol) can be changed for each program via Settings – Programming using the +/- keys.

6.5.4 Renaming

Via Settings – Renaming, the keyboard can be selected, provided the currently selected program is not write-protected. The desired letters can be selected using the cursor keys (circular). The letter is selected with the ENTER key. Individual letters may be deleted using the delete key (arrow symbol).

Changes are saved by pressing the save (disk symbol) or ESC key. This will also close the keyboard screen.

P 4 TES
Q W E R T Z U I O P
A S D F G H J K L
Y X C V B N M

This key enables switching to lower case letters, numbers/symbols and back to capital letters.

7. Maintenance, Cleaning and Diagnosis

This chapter describes the user maintenance and cleaning procedures for the Programat S1. All the other tasks must be performed by qualified service personnel at a certified Ivoclar Vivadent Service Center.

7.1 Cleaning of the sintering chamber and the heating elements

7.1.1 Visual inspection of the sintering chamber

Inspect the sintering chamber visually prior to every sintering procedure. No foreign objects or dirt particles must be present in the sintering chamber during the sintering procedure.

Contaminations may be due to a chipping of the oxide / protective layer of the heating element surface, among others. This type of contamination may have an effect on the optical properties (discolouration) of the sintered object.

Contaminations resulting from chipping-off of the oxide layer can be classified as follows:

Type of contamination	Indicator
Glass particles	The insulation of the lower part of the furnace / the sinter tray rest shows residue of clearly visible, glassy transparent particles (see image a).
Fine glass dust	The insulation of the lower part of the furnace and the cooling tray show residue of fine glass dust. This type of contamination is more difficult to discern.

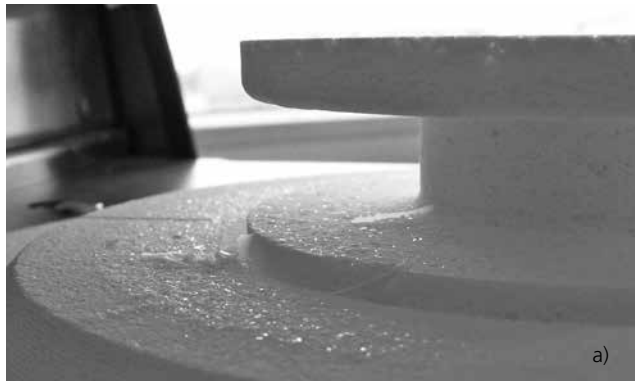

If glass particles or fine glass dust are noticed during the visual inspection, the sintering chamber needs to be cleaned (see section 7.1.2) and a firing cycle with Program 1 (IPS e.max ZirCAD crown) must be conducted with an empty firing chamber. For this cycle, no ZrO₂ objects must be placed in the furnace.

7.1.2 Cleaning of the sintering chamber

Use the enclosed cleaning brush (102) for cleaning. Do not use compressed air for cleaning under any circumstances. After cleaning, conduct a cycle with the Program 1 (IPS e.max ZirCAD crowns) with the firing chamber empty. In case of severe contamination it is recommended to conduct the cleaning program (see section 7.1.3).



7.1.3 Cleaning of the heating elements

The cleaning program recreates the chipped off oxide / protective layer on the heating elements.

If no smooth protective layer is visible on the heating elements after a cleaning firing, several subsequent cleaning firings may be necessary. Do not place ZrO₂ objects in the furnace for these firings.

Clean the sintering chamber prior to conducting the cleaning program.



Large parts of the protective layer on the left heating element have chipped off. The heating element on the right side is in a sound, stable condition and shows an intact oxide / protective layer. The cleaning program must be repeated until the surface is free from contamination and appears glassy.

7.2 Monitoring and maintenance

The time for these maintenance procedures depends on the frequency of use and the working habits of the users. For that reason, the recommended times are only approximations.



This furnace has been developed for typical use in dental laboratories. If the product is used in a production enterprise, for industrial applications and for continuous use, premature ageing of the expendable parts has to be expected.

The expendable parts are as follows:

- Heating muffle
- Insulation material

Expendable parts are not covered by the warranty. Please also observe the shorter service and maintenance intervals.

What:	Measure:	When:
Check all plug-in connections for correct fit	Var. external connections	weekly
Check if the furnace head opens smoothly and without excessive noise	Opening mechanism	monthly
Check if the thermocouple is straight and in the right place	Thermocouple (2)	weekly
Check the insulation for cracks and damages. If the insulation is worn down it has to be replaced by a certified Ivoclar Vivadent Service Centre. Fine hair-line cracks on the surface of the insulation are harmless and do not influence the function of the furnace in a negative fashion.	Insulation (1)	monthly
Check the keypad for visible damage. If the keypad is damaged, it has to be replaced by a certified Ivoclar Vivadent Service Centre.	Keypad (8)	weekly
Check temperature. Use the temperature checking set to check and adjust the temperature in the furnace.	Firing chamber	twice a year



If the furnace head is replaced with a furnace head from another Programat S1, calibration is required.

7.3 Cleaning



The furnace may only be cleaned when it is cool, since there is a burn hazard. Do not use any cleaning solutions. Disconnect the furnace from the power source before cleaning.

The following parts have to be cleaned from time to time:

Item:	Frequency:	Cleaning Material:
Furnace housing (7) and furnace head	if required	soft, dry cloth
Membrane-sealed keypad (8)	weekly	soft, dry cloth
Cooling tray (26)	daily	cleaning brush*
Isolation (1)	daily	cleaning brush*

*Never use compressed air!

7.4 Test programs

Press the Settings key and scroll to the desired test program using the cursor keys.

Heater test program

The heater test automatically checks the heating system. The test should only be performed with the firing chamber empty, since any mass placed in the furnace (e.g. sinter tray) would influence the result.

Keypad test program

Each pressing of a key results in a short beep. The keypad test can be closed using the ESC key.

Cleaning program

The heating elements are „cleaned“ and/or regenerated using the cleaning program.

7.5 Stand-by

We recommend keeping the furnace head closed during stand-by to prevent damage.

7.6 Temperature calibration

The temperature level in the sintering chamber may change after prolonged operating hours (e.g. by contamination, wear and tear of the heating elements etc.). For optimum function, regular recalibration is required. The Temperature Checking Set S1 has been specially developed for this purpose. This set is used to calibrate the temperature of your sinter furnace.

The calibration with sinter rings enables the verification of the holding temperature of 1500 °C/2732 °F required for sintering the ZrO₂ blocks in the sintering chamber.

During the sinter process, the rings change their dimensions due to shrinkage. The shrinkage of the sinter rings is decisive for the correction value of the furnace and can be found on the conversion table.

For calibration, you need sinter rings, a measuring device (slide gauge) and a conversion table (enclosed in the Temperature Checking Set 1).

Procedure:

1. Press the Settings key (78) to access the Settings screen. Select „Temperature Calibration“ using the cursor keys (79/80). The following display appears:

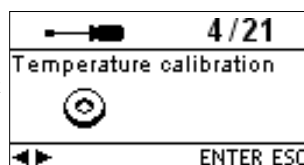

The calibration program is selected with the ENTER key. The following display appears:

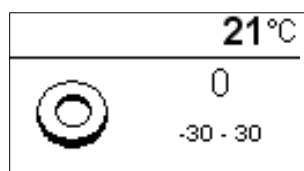

2. Position the sinter ring (a) in the center of the sinter tray (b)

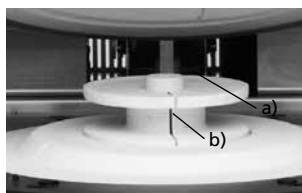

3. Press the START key. The furnace head is automatically closed and the calibration program started.

4. After the end of the program, carefully remove the sintered sinter ring and allow it to cool to room temperature on the cooling tray.

5. Place the cool ring on an even surface and determine the exact diameter using the slide gauge. Make sure that the ring is flush with the two arms of the slide gauge. Conduct the measurement in that area of the ring, where the batch number (c) has been stamped into the ring.



6. Find the measured diameter in the conversion table and read off the corresponding temperature. Only if the deviations is more than 10 °C / 18°F must the furnace be readjusted.
7. If the temperature difference is higher than 10 °C / 18 °F (target temperature = 1500 °C/2732 °F) the correction value can be transferred to the furnace with the help of the +/- keys (76/77). Each keystroke changes the furnace temperature by 1 °C. Once the desired correction value has been entered, the program can be closed by pressing the ESC key (71).

Calibration is now complete. Close the furnace head or select a sintering program.

i For further information about the calibration, please refer to the note accompanying the Temperature Checking Set S1.

7.7 Service Hint

When the Service Hint appears for the first time (Hint 1700), 2 years have passed or the heating elements have been in use for more than 1200 firing hours. For this reason, Ivoclar Vivadent recommends a maintenance and service procedure. For further information, please refer to the Equipment Service Passport. The interval until the next appearance of the Service Hint can be selected in the settings (see Chapter 5.6.1).

8. What if ...

This chapter will help you to recognize malfunctions and take appropriate measures.

8.1 Error messages

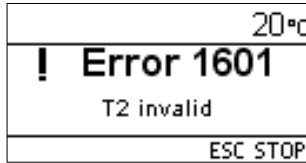

The furnace continuously monitors all functions during operation. As soon as an error is found, a corresponding error message will appear. In case of an error, the heater is switched off for safety reasons.

The following error messages may be displayed:

Error / Hint No.	Continuation possible	Error	Error Message Text
17		Power failure >10 s during a program in progress	A firing program in progress was interrupted for more than 10 s. The program cannot be continued!
20	no	Error in the heating system	Check the heater fuse. If the fuse is OK, contact your local Service Center.
27 *,**	no	Furnace head cannot be initialized	The furnace head cannot be moved to the final position. It might be blocked by an external mechanical source! If this is not the case, please contact your local Service Center!
28 **		Furnace head does not reach the target position.	The furnace head does not open/close correctly. The furnace head was manually moved or is obstructed. The furnace head must only be moved using the keys intended for this purpose!
702		Short power failure during a program in progress	A program in progress was interrupted by a short power failure. The program continues.
1310		Calibration reminder	Some time has passed since the last calibration. Conduct a calibration procedure soon.
1600		T1 < B	Enter a reasonable value for T.
1601		T2 < T1	Enter a reasonable value for T.
1602		T3 < T2 für T2 > 0, T3 > 0 für T2=0	Enter a reasonable value for T.
1603		T4 > Tx (T1, T2, T3)	Enter a reasonable value for T.
1604		T5 > T4	Enter a reasonable value for T.
1613		Current temperature after Start > Tx + 80 °C/176 °F.	Caution! Excess Temperature! The program was aborted.
1626		Current Temperature > 700 °C/1292 °F upon Start	Sintering chamber is too hot for the start of a sintering program.
1650		PwrUnit	Error Power-Unit. Check the fuse and the electric plug-in connections to the furnace head. The unit is not ready for operation! Please contact the Ivoclar Vivadent After Sales Service.
1660		HeadOpenDisabled (T too high)	Temperature too high for opening the furnace head
1661		Power outage >10 sec with the sintering program started and in the heating stage	Long power outage during a sintering program in progress. Repeat the sintering program.
1662		Power out >10 sec with the sintering program started and in the critical heating stage	Long power outage during a sintering program in progress. The objects are probably not OK.
1700		Service Hint	More than two years have passed since the last technical inspection or the heating elements have been in use for more than 1200 firing hours. For this reason, Ivoclar Vivadent recommends a maintenance and service procedure. For further information, please refer to the Equipment Service Passport. The interval until the next appearance of the Service Hint can be selected in the settings (see Chapter 5.6.1).

* A program in progress is stopped!

** The error cannot be acknowledged; the programs cannot be started!

If one of the following error numbers appear, contact your local Ivoclar Vivadent Service After Sales Service:

- 25, 29
- 54, 56
- 103, 107
- 700, 701, 705, 706, 707
- 1010, 1011, 1012, 1013, 1014, 1015, 1016
- 1024, 1025, 1026, 1028
- 1202, 1203, 1204, 1205, 1206, 1207
- 1400, 1401, 1402
- 1500
- 1630, 1631, 1632, 1650, 1651, 1652



If an ongoing sinter process is interrupted by an error message, the objects should not be used for patient cases. This note does not apply to the error messages 702 and 1661.

8.2 Technical malfunctions

These malfunctions may occur without an error message being displayed:

Error	Double Check	Measure
Display indication incomplete		Activate the display test program and contact the Ivoclar Vivadent After Sales Service.
Writing in the display is very hard to read	Is the contrast properly set?	Adjust contrast
Display is not illuminated	Is the furnace properly connected according to the Operation Instructions and switched on?	Correctly connect the furnace and switch it on.
Buzzer does not sound	Is the buzzer switched off (Tune 0)?	Select tune 1–5
Furnace head does not open	Was the furnace head opened manually?	Open the furnace head only by using the corresponding keys. Switch the furnace on and off again.
Incorrect or illogical temperature indication	Is the thermocouple bent or fractured?	Contact the Ivoclar Vivadent After Sales Service
	Is the thermocouple correctly connected?	Correctly connect the thermocouple
	Is the thermocouple plug defective?	Contact the Ivoclar Vivadent After Sales Service
Cracks in the insulation of the sintering chamber	Are the cracks very small and insignificant (hairline cracks)?	Small cracks in the insulation do not negatively influence the furnace.
	Are the cracks large or have parts of the sintering chamber broken off?	Contact the Ivoclar Vivadent After Sales Service
Cracks in the insulation	Are the cracks very small and insignificant (hairline cracks)?	Small cracks in the insulation do not negatively influence the furnace.
	Are the cracks large or have parts broken off?	Contact the Ivoclar Vivadent After Sales Service
Damage of a heating element	Is a heating element bent or fractured?	Switch off the furnace and contact the Ivoclar Vivadent After Sales Service
Damage of the thermocouple	Is the thermocouple damaged or broken off?	Contact the Ivoclar Vivadent After Sales Service

8.3 Repair



Repairs may only be carried out by a certified Ivoclar Vivadent After Sales Service Centre. Please refer to the addresses in Chapter 10.

If repairs during the warranty period are not carried out by a certified Ivoclar Vivadent After Sales Service Center, the warranty will expire immediately. Please also refer to the corresponding warranty regulations.

9. Product Specifications

9.1 Delivery form

- Programat S1
- Power cord
- Temperature Checking Set S1 Starter Kit
- Operating Instructions
- Sinter tray
- Sinter tray fork
- USB download cable
- Equipment Service Passport
- Various accessories

9.2 Technical data

Power supply 118–240 V / 50–60 Hz

Overvoltage category II
Contamination level 2

Acceptable voltage fluctuations +/- 10%

Max. power consumption 16 A at 118 V

8 A at 240 V

Electrical fuses 250 V / T16 A high breaking (heating circuit)

Dimensions electrical fuses Diameter 5 x 20 mm

Dimensions of the closed furnace
Depth: 430 mm / Width: 310 mm / 390 mm (with cooling tray)
Height: 570 mm

Usable size of the sintering chamber
Diameter 80 mm
Height 80 mm

Max. firing temperature 1530 °C/2786 °F

Weight
Furnace base: 10 kg
Furnace head: 17 kg

Safety information

The sinter furnace complies with the following guidelines:

- IEC 61010-1:2001
- EN 61010-1:2001
- UL 61010-1:2004
- CAN/CSA-C22.2 No. 61010-1:2004
- IEC 61010-2-010:2003
- EN 61010-2-010:2003
- CAN/CSA-C22.2 No. 61010-2-010:2004

Radio protections / electromagnetic compatibility EMV tested

9.3 Acceptable operating conditions

Acceptable ambient temperature range:
+5°C to +40°C (+41°F to +104°F)

Acceptable humidity range:
80 % maximum relative humidity for temperatures up to 31°C
(87.8° F) gradually decreasing to 50 % relative humidity
at 40°C (104°F); condensation excluded.

Acceptable ambient pressure:
The furnace is tested for use at altitudes of
up to 2000 m above sea level.

9.4 Acceptable transportation and storage conditions

Acceptable temperature range -20 to +65°C (-4°F to +149°F)
Acceptable humidity range Max. 80% relative humidity
Acceptable ambient pressure 500 mbar to 1060 mbar

Use only original packaging of the Programat S1 together with the
respective foam material for shipping purposes.

10. Miscellaneous

10.1 Program table

A program table is enclosed in these Operating Instructions. Should this not be the case, please contact the Ivoclar Vivadent Service Center.



Important information

The current program tables are also available at:

www.ivoclarvivadent.com/downloadcenter

The program tables can be downloaded from the Internet as PDF files. Please note, that the version of the program table should correspond to the software version which is used on your furnace.

Ivoclar Vivadent – worldwide

Ivoclar Vivadent AG
Bendererstrasse 2
9494 Schaan
Liechtenstein
Tel. +423 235 35 35
Fax +423 235 33 60
www.ivoclarvivadent.com

Ivoclar Vivadent Pty. Ltd.
1 – 5 Overseas Drive
P.O. Box 367
Noble Park, Vic. 3174
Australia
Tel. +61 3 9795 9599
Fax +61 3 9795 9645
www.ivoclarvivadent.com.au

Ivoclar Vivadent GmbH
Tech Gate Vienna
Donau-City-Strasse 1
1220 Wien
Austria
Tel. +43 1 263 191 10
Fax: +43 1 263 191 111
www.ivoclarvivadent.at

Ivoclar Vivadent Ltda.
Alameda Caiapós, 723
Centro Empresarial Tamboré
CEP 06460-110 Barueri – SP
Brazil
Tel. +55 11 2424 7400
Fax +55 11 3466 0840
www.ivoclarvivadent.com.br

Ivoclar Vivadent Inc.
1-6600 Dixie Road
Mississauga, Ontario
L5T 2Y2
Canada
Tel. +1 905 670 8499
Fax +1 905 670 3102
www.ivoclarvivadent.us

Ivoclar Vivadent Shanghai Trading Co., Ltd.
2/F Building 1, 881 Wuding Road,
Jing An District
200040 Shanghai
China
Tel. +86 21 6032 1657
Fax +86 21 6176 0968
www.ivoclarvivadent.com

Ivoclar Vivadent Marketing Ltd.
Calle 134 No. 7-B-83, Of. 520
Bogotá
Colombia
Tel. +57 1 627 3399
Fax +57 1 633 1663
www.ivoclarvivadent.co

Ivoclar Vivadent SAS
B.P. 118
F-74410 Saint-Jorioz
France
Tel. +33 4 50 88 64 00
Fax +33 4 50 68 91 52
www.ivoclarvivadent.fr

Ivoclar Vivadent GmbH
Dr. Adolf-Schneider-Str. 2
D-73479 Ellwangen, Jagst
Germany
Tel. +49 7961 889 0
Fax +49 7961 6326
www.ivoclarvivadent.de

Wieland Dental + Technik GmbH & Co. KG
Schwenninger Strasse 13
D-75179 Pforzheim
Germany
Tel. +49 7231 3705 0
Fax +49 7231 3579 59
www.wieland-dental.com

Ivoclar Vivadent Marketing (India) Pvt. Ltd.
503/504 Raheja Plaza
15 B Shah Industrial Estate
Veera Desai Road, Andheri (West)
Mumbai, 400 053
India
Tel. +91 22 2673 0302
Fax +91 22 2673 0301
www.ivoclarvivadent.in

Ivoclar Vivadent s.r.l.
Via Isonzo 67/69
40033 Casalecchio di Reno (BO)
Italy
Tel. +39 051 6113555
Fax +39 051 6113565
www.ivoclarvivadent.it

Ivoclar Vivadent K.K.
1-28-24-4F Hongo
Bunkyo-ku
Tokyo 113-0033
Japan
Tel. +81 3 6903 3535
Fax +81 3 5844 3657
www.ivoclarvivadent.jp

Ivoclar Vivadent Ltd.
12F W-Tower, 1303-37
Seocho-dong, Seocho-gu,
Seoul 137-855
Republic of Korea
Tel. +82 2 536 0714
Fax +82 2 596 0155
www.ivoclarvivadent.co.kr

Ivoclar Vivadent S.A. de C.V.
Av. Insurgentes Sur No. 863,
Piso 14, Col. Napoles
03810 México, D.F.
México
Tel. +52 55 5062 1000
Fax +52 55 5062 1029
www.ivoclarvivadent.com.mx

Ivoclar Vivadent BV
De Fruittuinen 32
2132 NZ Hoofddorp
Netherlands
Tel. +31 23 529 3791
Fax +31 23 555 4504
www.ivoclarvivadent.com

Ivoclar Vivadent Ltd.
12 Omega St, Rosedale
PO Box 303011 North Harbour
Auckland 0751
New Zealand
Tel. +64 9 914 9999
Fax +64 9 914 9990
www.ivoclarvivadent.co.nz

Ivoclar Vivadent Polska Sp. z o.o.
Al. Jana Pawla II 78
00-175 Warszawa
Poland
Tel. +48 22 635 5496
Fax +48 22 635 5469
www.ivoclarvivadent.pl

Ivoclar Vivadent Marketing Ltd.
Prospekt Andropova 18 korp. 6/
office 10-06
115432 Moscow
Russia
Tel. +7 499 418 0300
Fax +7 499 418 0310
www.ivoclarvivadent.ru

Ivoclar Vivadent Marketing Ltd.
Qlaya Main St.
Siricon Building No.14, 2nd Floor
Office No. 204
P.O. Box 300146
Riyadh 11372
Saudi Arabia
Tel. +966 11 293 8345
Fax +966 11 293 8344
www.ivoclarvivadent.com

Ivoclar Vivadent S.L.U.
Carretera de Fuencarral n°24
Portal 1 – Planta Baja
28108-Alcobendas (Madrid)
Spain
Telf. +34 91 375 78 20
Fax: +34 91 375 78 38
www.ivoclarvivadent.es

Ivoclar Vivadent AB
Dalvägen 14
S-169 56 Solna
Sweden
Tel. +46 8 514 939 30
Fax +46 8 514 939 40
www.ivoclarvivadent.se

Ivoclar Vivadent Liaison Office
: Tesvikiye Mahallesi
Sakayik Sokak
Nisantas' Plaza No:38/2
Kat:5 Daire:24
34021 Sisli – Istanbul
Turkey
Tel. +90 212 343 0802
Fax +90 212 343 0842
www.ivoclarvivadent.com

Ivoclar Vivadent Limited
Ground Floor Compass Building
Feldspar Close
Warrens Business Park
Enderby
Leicester LE19 4SE
United Kingdom
Tel. +44 116 284 7880
Fax +44 116 284 7881
www.ivoclarvivadent.co.uk

Ivoclar Vivadent, Inc.
175 Pineview Drive
Amherst, N.Y. 14228
USA
Tel. +1 800 533 6825
Fax +1 716 691 2285
www.ivoclarvivadent.us

Version: 4

Date of issue: 2014-07

Valid from software version V3.0

This apparatus has been developed solely for use in dentistry. Start-up and operation should be carried out strictly according to the Operating Instructions. Liability cannot be accepted for damages resulting from misuse or failure to observe the Instructions. The user is solely responsible for testing the apparatus for its suitability for any purpose not explicitly stated in the Instructions. Descriptions and data constitute no warranty of attributes.

Printed in Austria
© Ivoclar Vivadent AG, Schaan/Liechtenstein
630461/en

**ivoclar**
vivadent
technical